

Ethernet empty MCU card for 100-pin TQFP Stellaris® 9000 series

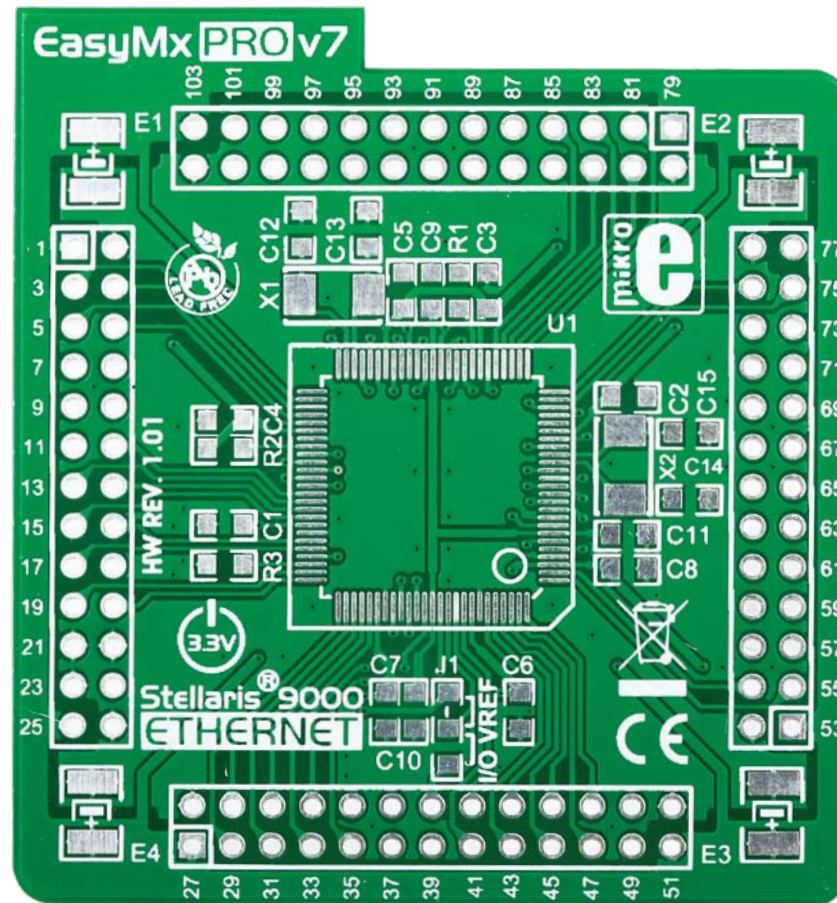

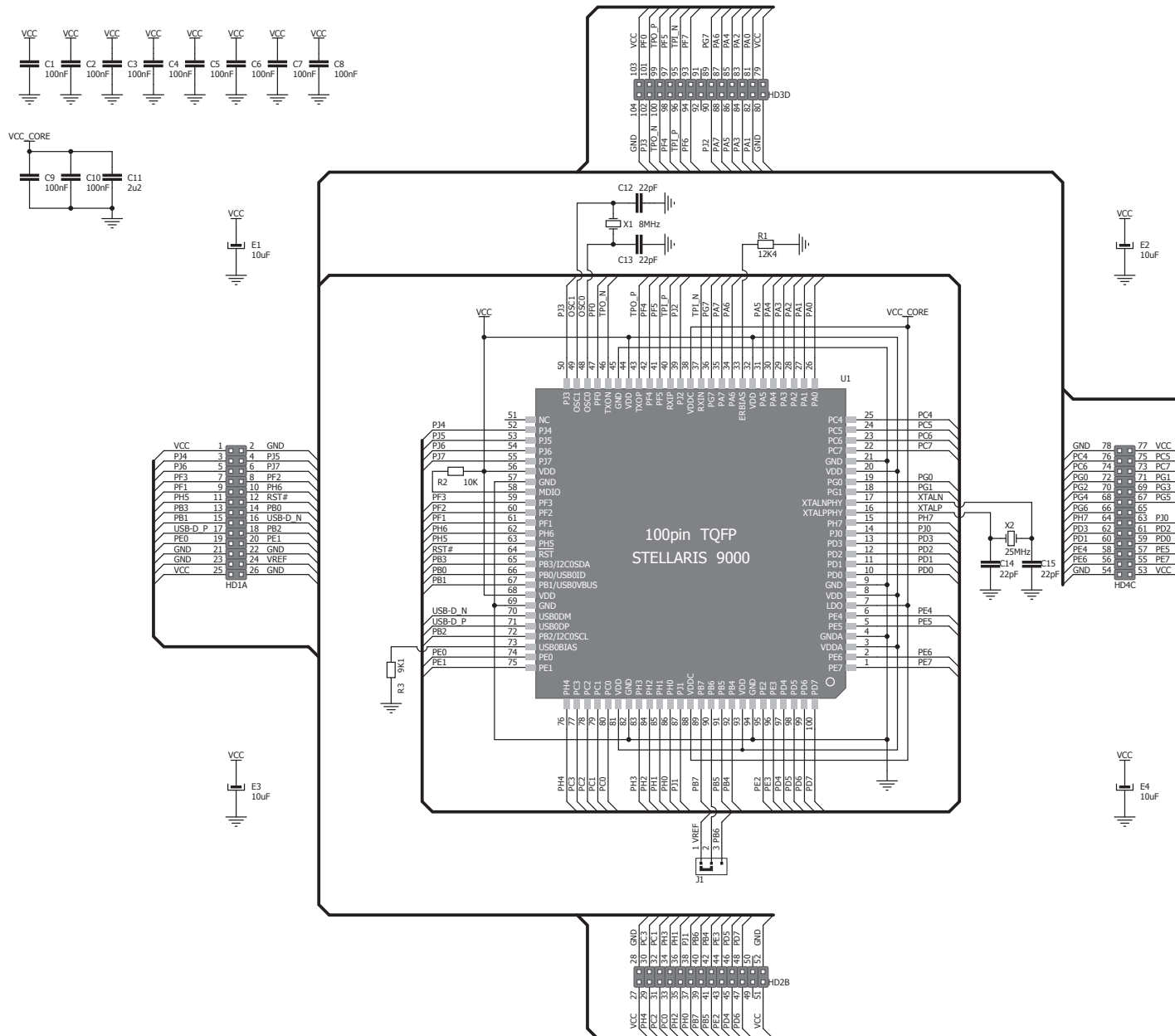

Figure 1: MCU card schematics

Card dimensions

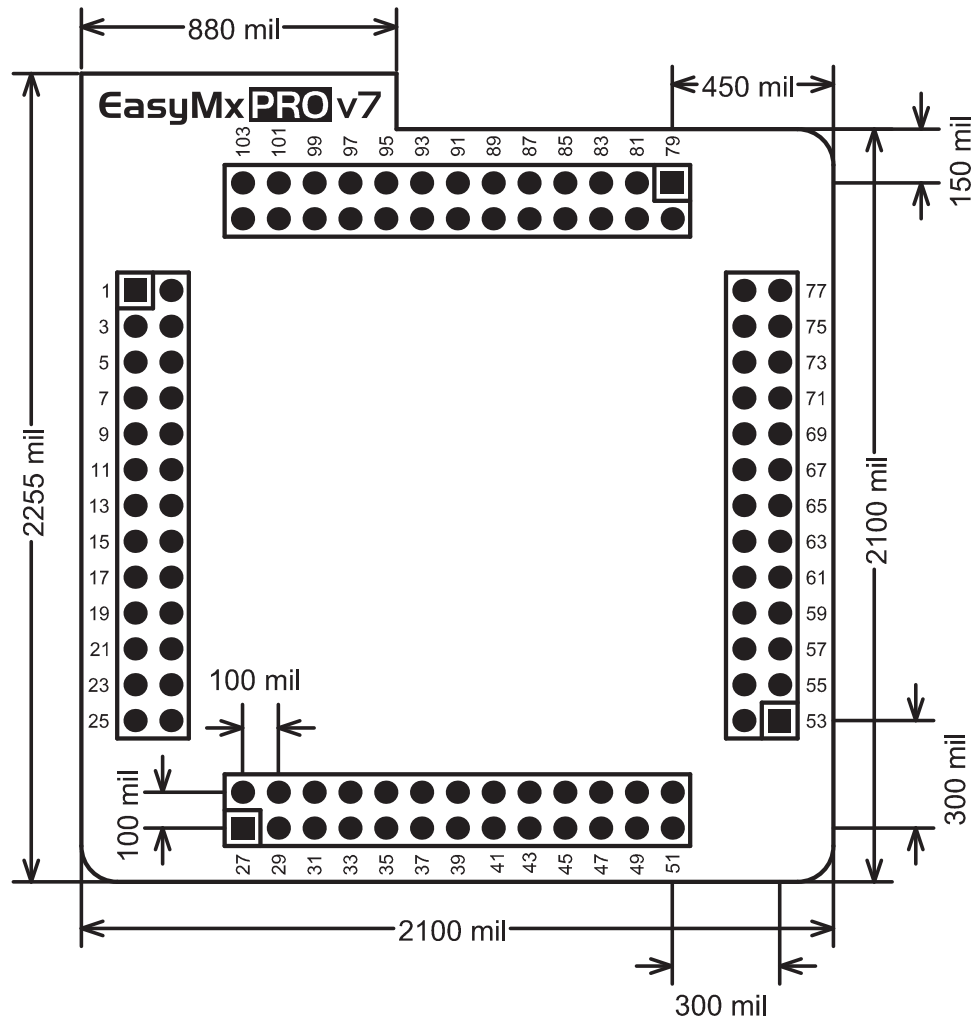
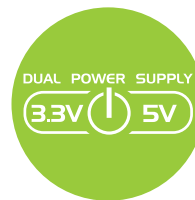
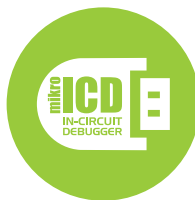

Figure 2: MCU card dimensions. Values are in mils.



If you want to learn more about our products, please visit our website at www.mikroe.com

If you are experiencing some problems with any of our products or just need additional information, please place your ticket at www.mikroe.com/esupport

If you have any questions, comments or business proposals, do not hesitate to contact us at office@mikroe.com