

20 W + 20 W dual BTL class-D audio amplifier

Datasheet - production data

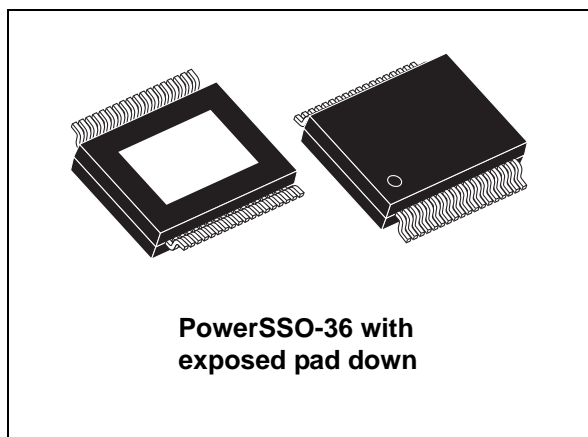

Description

The TDA7491HV is a dual BTL class-D audio amplifier with single power supply designed for LCD TVs and monitors.

Thanks to the high efficiency and exposed-pad-down (EPD) package no separate heatsink is required.

The TDA7491HV is pin-to-pin compatible with the TDA7491P and TDA7491LP.

Features

- 20 W + 20 W continuous output power:
 $R_L = 8 \Omega$, THD = 10% at $V_{CC} = 18 \text{ V}$
- Wide-range single-supply operation (5 V - 18 V)
- High efficiency ($\eta = 90\%$)
- Four selectable, fixed gain settings of nominally 20 dB, 26 dB, 30 dB and 32 dB
- Differential inputs minimize common mode noise
- No 'pop' at turn-on/off
- Standby and mute features
- Short-circuit protection
- Thermal overload protection
- Externally synchronizable

Table 1. Device summary

Order code	Operating temperature	Package	Packaging
TDA7491HV13TR	-40 to 85°C	PowerSSO-36 EPD	Tape and reel

Contents

- 1 Device block diagram 7**
- 2 Pin description 8**
 - 2.1 Pinout 8
 - 2.2 Pin list 9
- 3 Electrical specifications 10**
 - 3.1 Absolute maximum ratings 10
 - 3.2 Thermal data 10
 - 3.3 Electrical specifications 10
- 4 Characterization curves 12**
 - 4.1 With 4 Ω load at V_{CC} = 14 V 12
 - 4.2 With 6 Ω load at V_{CC} = 16 V 17
 - 4.3 With 8 Ω load at V_{CC} = 18 V 23
 - 4.4 Test board 29
- 5 Package mechanical data 30**
- 6 Applications circuit 32**
- 7 Application information 33**
 - 7.1 Mode selection 33
 - 7.2 Gain setting 34
 - 7.3 Input resistance and capacitance 34
 - 7.4 Internal and external clocks 36
 - 7.4.1 Master mode (internal clock) 36
 - 7.4.2 Slave mode (external clock) 36
 - 7.5 Modulation 37
 - 7.6 Reconstruction low-pass filter 39
 - 7.7 Protection functions 40
 - 7.8 Diagnostic output 40
 - 7.9 Heatsink requirements 40



8 Revision history 42

List of tables

Table 1.	Device summary	1
Table 2.	Pin description list	9
Table 3.	Absolute maximum ratings	10
Table 4.	Thermal data	10
Table 5.	Electrical specifications	10
Table 6.	PowerSSO-36 EPD dimensions	31
Table 7.	Mode settings	33
Table 8.	Gain settings	34
Table 9.	How to set up SYNCLK	36
Table 10.	Document revision history	42

List of figures

Figure 1.	Internal block diagram (one channel only)	7
Figure 2.	Pin connections (top view, PCB view)	8
Figure 3.	Output power vs. supply voltage	12
Figure 4.	THD vs. output power (1 kHz)	12
Figure 5.	THD vs. output power (100 Hz)	13
Figure 6.	THD vs. frequency	13
Figure 7.	Frequency response	13
Figure 8.	Crosstalk vs. frequency	14
Figure 9.	FFT (0 dB)	14
Figure 10.	FFT (-60 dB)	14
Figure 11.	Power supply rejection ratio vs. frequency	15
Figure 12.	Power dissipation and efficiency vs. output power	15
Figure 13.	Closed-loop gain vs. frequency	15
Figure 14.	Current consumption vs. voltage on pin MUTE	16
Figure 15.	Attenuation vs. voltage on pin MUTE	16
Figure 16.	Current consumption vs. voltage on pin STBY	16
Figure 17.	Attenuation vs. voltage on pin STBY	17
Figure 18.	Output power vs. supply voltage	17
Figure 19.	THD vs. output power (1 kHz)	18
Figure 20.	THD vs. output power (100 Hz)	18
Figure 21.	THD vs. frequency	18
Figure 22.	Frequency response	19
Figure 23.	Crosstalk vs. frequency	19
Figure 24.	FFT (0 dB)	19
Figure 25.	FFT (-60 dB)	20
Figure 26.	Power supply rejection ratio vs. frequency	20
Figure 27.	Power dissipation and efficiency vs. output power	20
Figure 28.	Closed-loop gain vs. frequency	21
Figure 29.	Current consumption vs. voltage on pin MUTE	21
Figure 30.	Attenuation vs. voltage on pin MUTE	21
Figure 31.	Current consumption vs. voltage on pin STBY	22
Figure 32.	Attenuation vs. voltage on pin STBY	22
Figure 33.	Output power vs. supply voltage	23
Figure 34.	THD vs. output power (1 kHz)	23
Figure 35.	THD vs. output power (100 Hz)	24
Figure 36.	THD vs. frequency	24
Figure 37.	Frequency response	24
Figure 38.	Crosstalk vs. frequency	25
Figure 39.	FFT (0 dB)	25
Figure 40.	FFT (-60 dB)	25
Figure 41.	Power supply rejection ratio vs. frequency	26
Figure 42.	Power dissipation and efficiency vs. output power	26
Figure 43.	Closed-loop gain vs. frequency	26
Figure 44.	Current consumption vs. voltage on pin MUTE	27
Figure 45.	Attenuation vs. voltage on pin MUTE	27
Figure 46.	Current consumption vs. voltage on pin STBY	27
Figure 47.	Attenuation vs. voltage on pin STBY	28
Figure 48.	Test board (TDA7491HV) layout	29

Figure 49.	PowerSSO-36 EPD outline drawing	30
Figure 50.	Applications circuit for class-D amplifier	32
Figure 51.	Standby and mute circuits	33
Figure 52.	Turn-on/off sequence for minimizing speaker "pop"	34
Figure 53.	Device input circuit and frequency response	35
Figure 54.	Master and slave connection	37
Figure 55.	Unipolar PWM output	38
Figure 56.	Typical LC filter for an 8 Ω speaker	39
Figure 57.	Typical LC filter for a 4 Ω speaker	39
Figure 58.	Behavior of pin DIAG for various protection conditions	40
Figure 59.	Power derating curves for PCB used as heatsink	41

1 Device block diagram

Figure 1 shows the block diagram of one of the two identical channels of the TDA7491HV.

Figure 1. Internal block diagram (one channel only)

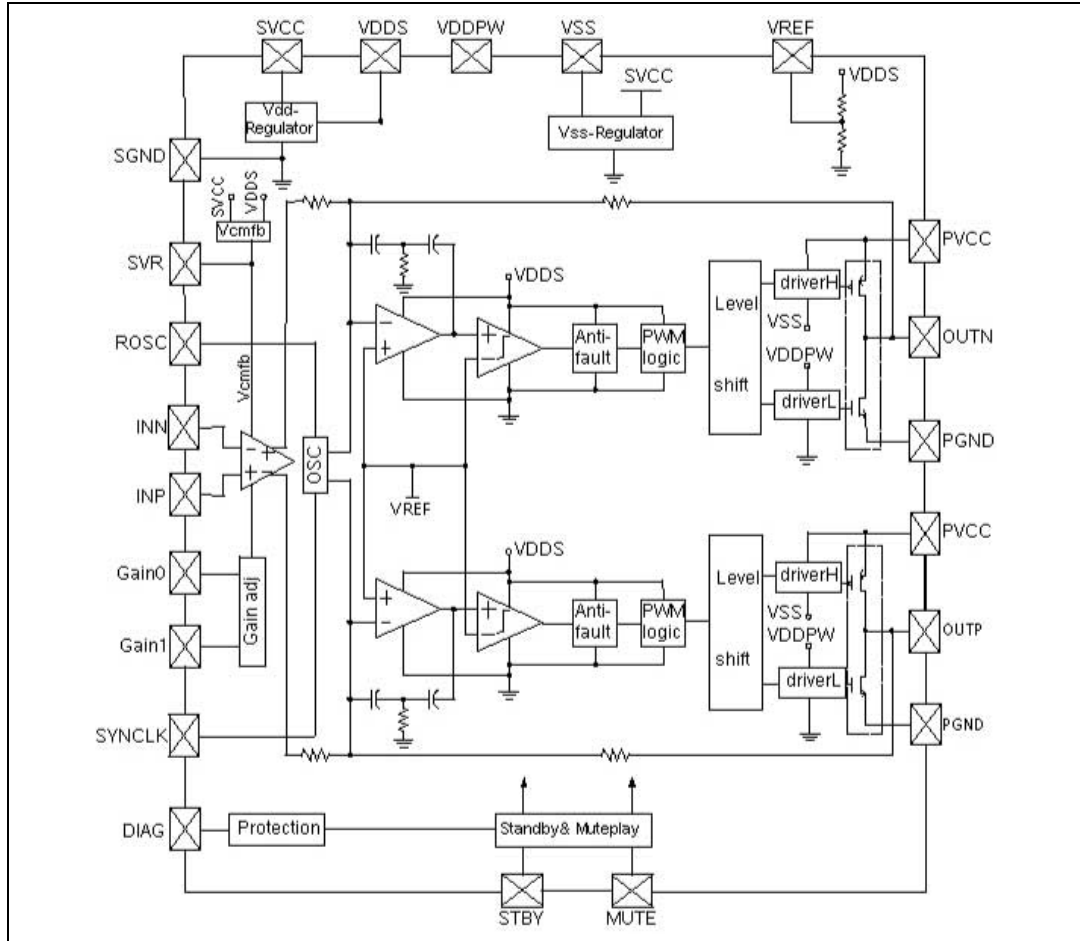

2 Pin description

2.1 Pinout

Figure 2. Pin connections (top view, PCB view)

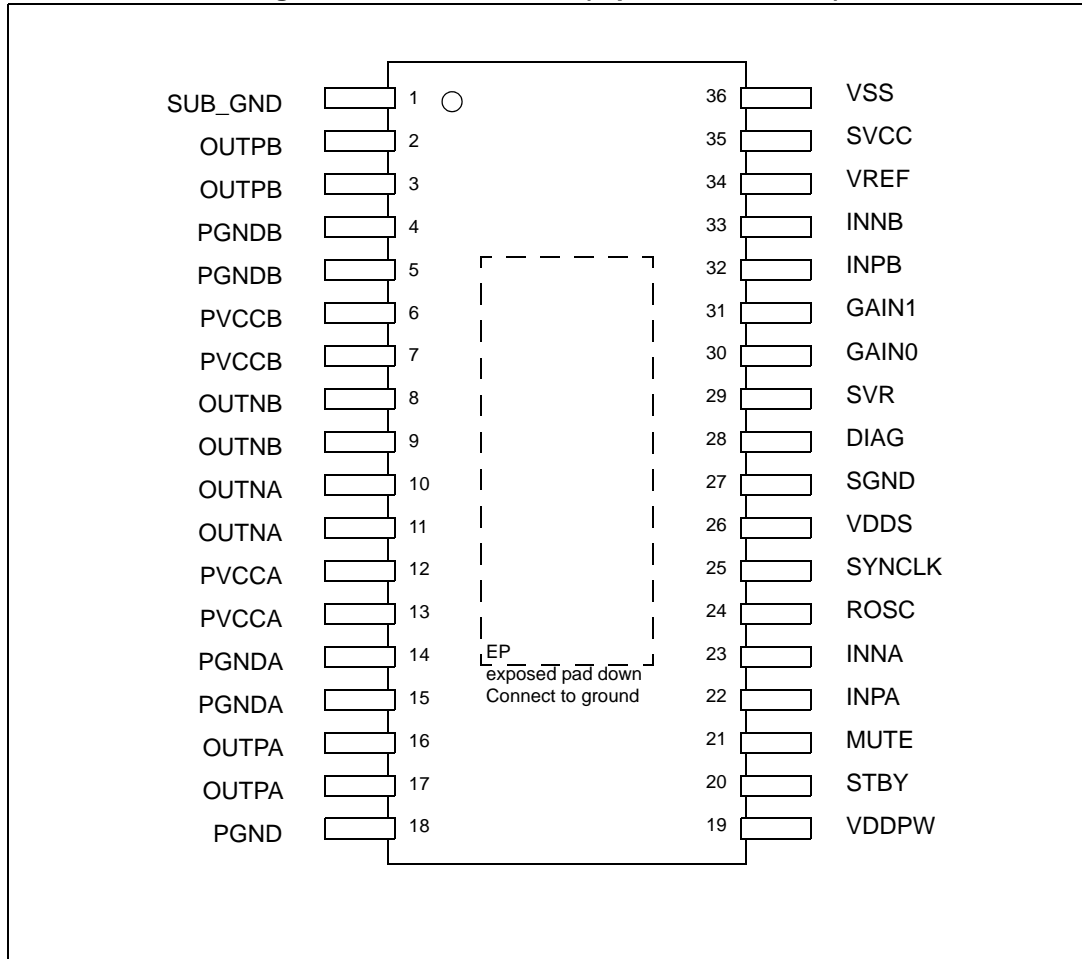

2.2 Pin list

Table 2. Pin description list

Pin n°	Name	Type	Description
1	SUB_GND	POWER	Connect to the frame
2,3	OUTPB	OUT	Positive PWM for right channel
4,5	PGNDB	POWER	Power stage ground for right channel
6,7	PVCCB	POWER	Power supply for right channel
8,9	OUTNB	OUT	Negative PWM output for right channel
10,11	OUTNA	OUT	Negative PWM output for left channel
12,13	PVCCA	POWER	Power supply for left channel
14,15	PGNDA	POWER	Power stage ground for left channel
16,17	OUTPA	OUT	Positive PWM output for left channel
18	PGND	POWER	Power stage ground
19	VDDPW	OUT	3.3-V (nominal) regulator output referred to ground for power stage
20	STBY	INPUT	Standby mode control
21	MUTE	INPUT	Mute mode control
22	INPA	INPUT	Positive differential input of left channel
23	INNA	INPUT	Negative differential input of left channel
24	ROSC	OUT	Master oscillator frequency-setting pin
25	SYNCLCK	IN/OUT	Clock in/out for external oscillator
26	VDDS	OUT	3.3-V (nominal) regulator output referred to ground for signal blocks
27	SGND	POWER	Signal ground
28	DIAG	OUT	Open-drain diagnostic output
29	SVR	OUT	Supply voltage rejection
30	GAIN0	INPUT	Gain setting input 1
31	GAIN1	INPUT	Gain setting input 2
32	INPB	INPUT	Positive differential input of right channel
33	INNB	INPUT	Negative differential input of right channel
34	VREF	OUT	Half VDDS (nominal) referred to ground
35	SVCC	POWER	Signal power supply
36	VSS	OUT	3.3-V (nominal) regulator output referred to power supply
-	EP	-	Exposed pad for ground-plane heatsink, to be connected to GND

3 Electrical specifications

3.1 Absolute maximum ratings

Table 3. Absolute maximum ratings

Symbol	Parameter	Value	Unit
V_{CC}	DC supply voltage for pins PVCCA, PVCCB	23	V
V_i	Voltage limits for input pins STBY,MUTE,INNA,INPA,INNB INPB,GAIN0,GAIN1	-0.3 TO 3.6	V
T_{op}	Operating temperature	-40 to 85	°C
T_j	Junction temperature	-40 to 150	°C
T_{stg}	Storage temperature	-40 to 150	°C

3.2 Thermal data

Refer also to [Section 7.9: Heatsink requirements on page 40](#).

Table 4. Thermal data

Symbol	Parameter	Min	Typ	Max	Unit
$R_{th\ j-case}$	Thermal resistance, junction to case	-	2	3	°C/W
$R_{th\ j-amb}$	Thermal resistance, junction to ambient (mounted on recommended PCB) ⁽¹⁾	-	24	-	

1. FR4 with vias to copper area of 9 cm².

3.3 Electrical specifications

Unless otherwise stated, the results in [Table 5](#) below are given for the conditions:

$V_{CC} = 18\text{ V}$, R_L (load) = 8 Ω , $R_{OSC} = R3 = 39\text{ k}\Omega$, $C8 = 100\text{ nF}$, $f = 1\text{ kHz}$, $G_V = 20\text{ dB}$, and $T_{amb} = 25\text{ °C}$.

Table 5. Electrical specifications

Symbol	Parameter	Condition	Min	Typ	Max	Unit
V_{CC}	Supply voltage	-	5	-	18	V
I_q	Total quiescent current	-	-	26	35	mA
I_{qSTBY}	Quiescent current in standby	-	-	2.5	5.0	μA
V_{OS}	Output offset voltage	Play mode	-100	-	100	mV
		Mute mode	-60	-	60	mV
I_{OCP}	Overcurrent protection threshold	$R_L = 0\ \Omega$	3	5	-	A
T_j	Junction temperature at thermal shutdown	-	-	150	-	°C
R_i	Input resistance	Differential input	54	60	-	k Ω

Table 5. Electrical specifications (continued)

Symbol	Parameter	Condition	Min	Typ	Max	Unit
V_{UVP}	Undervoltage protection threshold	-	-	-	4.5	V
R_{dsON}	Power transistor on resistance	High side	-	0.2	-	Ω
		Low side	-	0.2	-	
P_o	Output power	THD = 10%	-	20	-	W
		THD = 1%	-	16	-	
P_o	Output power	$R_L = 8 \Omega$, THD = 10% $V_{CC} = 12 V$	-	9.5	-	W
		$R_L = 8 \Omega$, THD = 1% $V_{CC} = 12 V$	-	7.2	-	
P_D	Dissipated power	$P_o = 20 W + 20 W$, THD = 10%	-	4.0	-	W
η	Efficiency	$P_o = 20 W + 20 W$	80	90	-	%
THD	Total harmonic distortion	$P_o = 1 W$	-	0.1	-	%
G_V	Closed loop gain	GAIN0 = L, GAIN1 = L	18	20	22	dB
		GAIN0 = L, GAIN1 = H	24	26	28	
		GAIN0 = H, GAIN1 = L	28	30	32	
		GAIN0 = H, GAIN1 = H	30	32	34	
ΔG_V	Gain matching	-	-1	-	1	dB
CT	Cross talk	$f = 1 \text{ kHz}$, $P_o = 1 W$	-	70	-	dB
eN	Total input noise	A Curve, $G_V = 20 \text{ dB}$	-	15	-	μV
		$f = 22 \text{ Hz to } 22 \text{ kHz}$	-	20	-	
SVRR	Supply voltage rejection ratio	$f_r = 100 \text{ Hz}$, $V_r = 1 V_{pp}$, $C_{SVR} = 10 \mu F$	-	50	-	dB
T_r, T_f	Rise and fall times	-	-	40	-	ns
f_{SW}	Switching frequency	Internal oscillator, master mode	290	320	350	kHz
f_{SWR}	Switching frequency range	(1)	250	-	400	kHz
V_{inH}	Digital input high (H)	-	2.3	-	-	V
V_{inL}	Digital input low (L)		-	-	0.8	
A_{MUTE}	Mute attenuation	$V_{MUTE} = \text{low}$ $V_{STBY} = \text{high}$	-	80	-	dB
Function mode	Standby, mute and play modes	$V_{STBY} < 0.5 V$ $V_{MUTE} = X$	Standby			-
		$V_{STBY} > 2.9 V$, $V_{MUTE} < 0.8 V$	Mute			-
		$V_{STBY} > 2.9 V$, $V_{MUTE} > 2.9 V$	Play			-

1. Refer to [Section 7.4: Internal and external clocks on page 36](#).

4 Characterization curves

The following characterization curves were made using the TDA7491HV demo board. The LC filter for the 4-Ω load uses components of 15 μH and 470 nF, whilst that for the 6-Ω load uses 22 μH and 220 nF and that for the 8-Ω load uses 33 μH and 220 nF.

4.1 With 4 Ω load at V_{CC} = 14 V

Figure 3. Output power vs. supply voltage

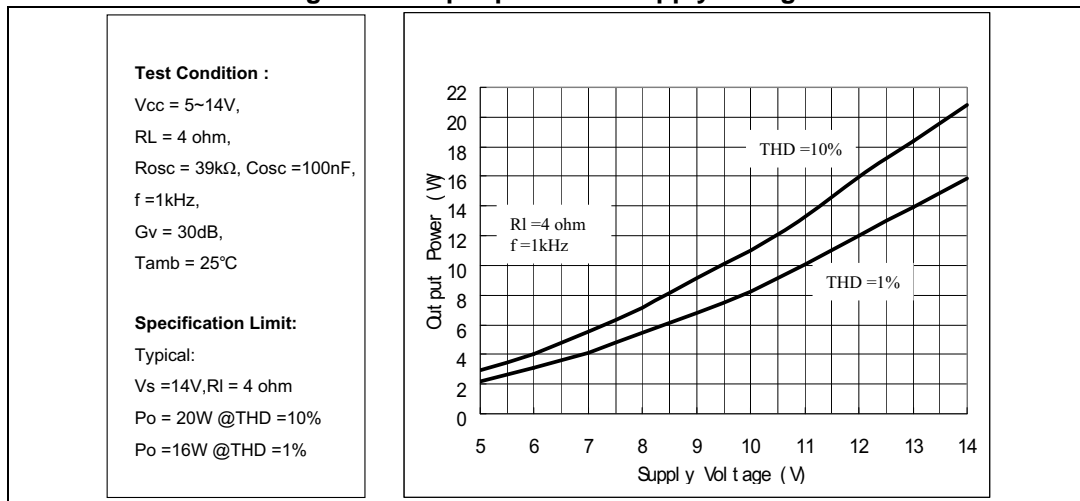

Figure 4. THD vs. output power (1 kHz)

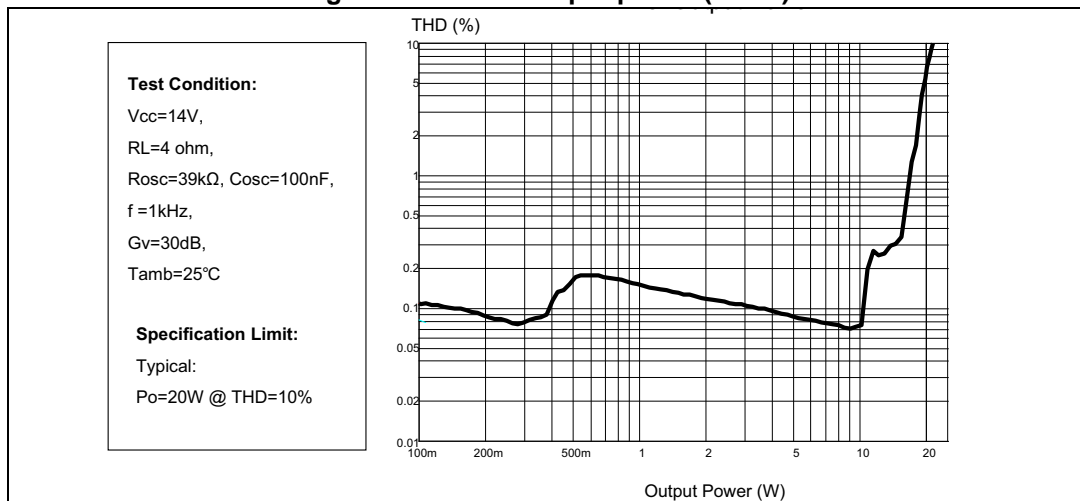

Figure 5. THD vs. output power (100 Hz)

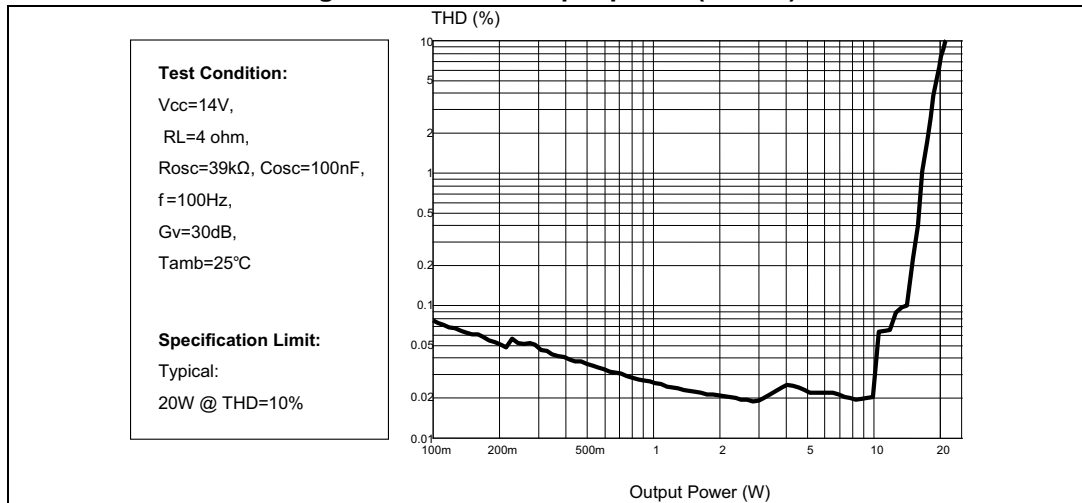

Figure 6. THD vs. frequency

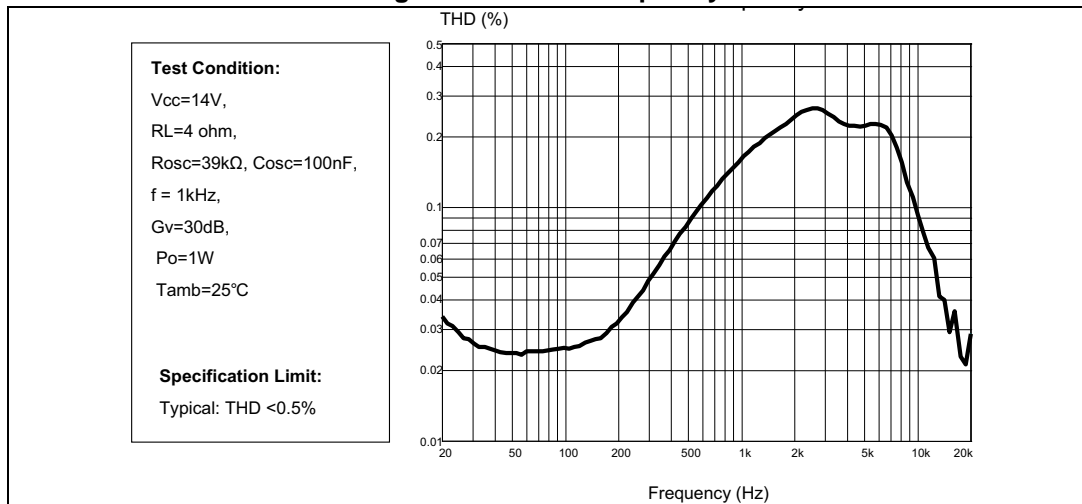

Figure 7. Frequency response

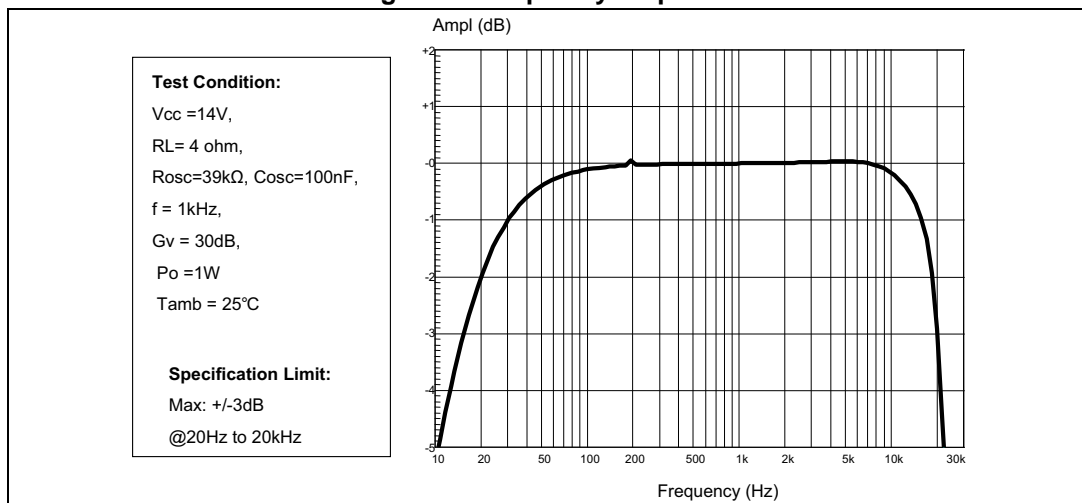

Figure 8. Crosstalk vs. frequency

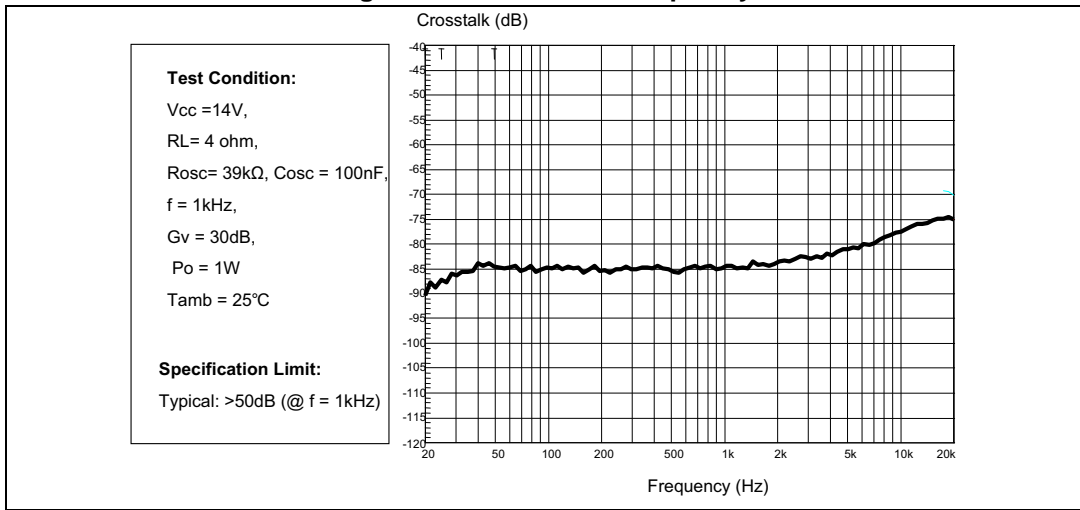

Figure 9. FFT (0 dB)

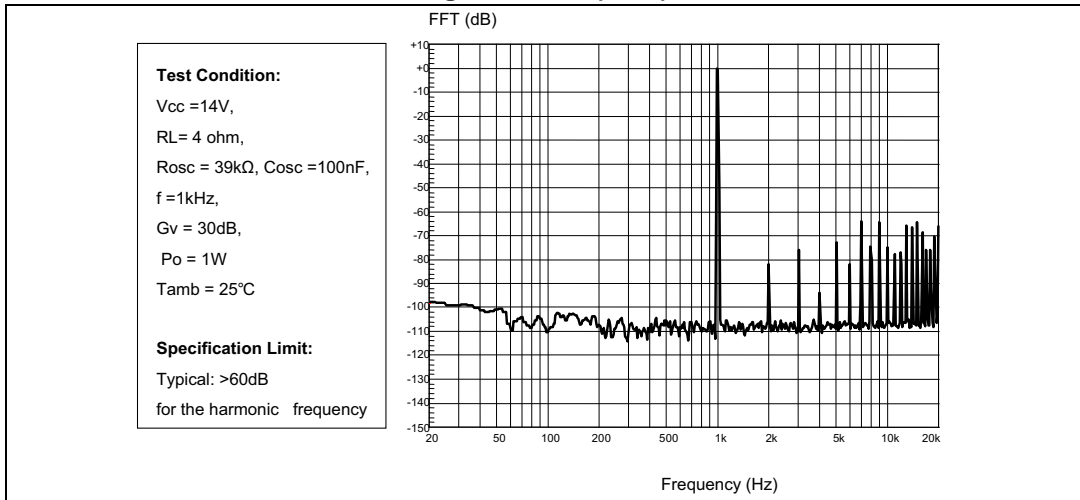

Figure 10. FFT (-60 dB)

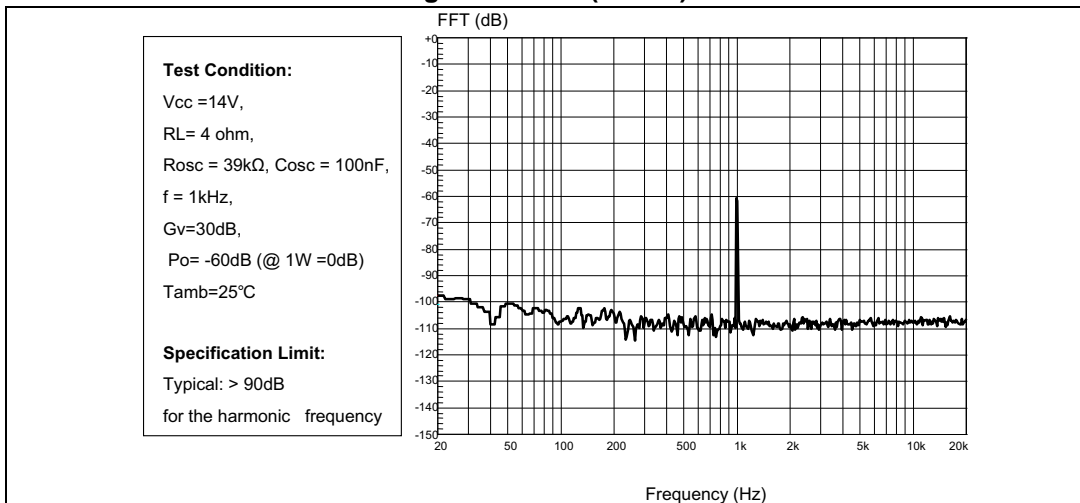

Figure 11. Power supply rejection ratio vs. frequency

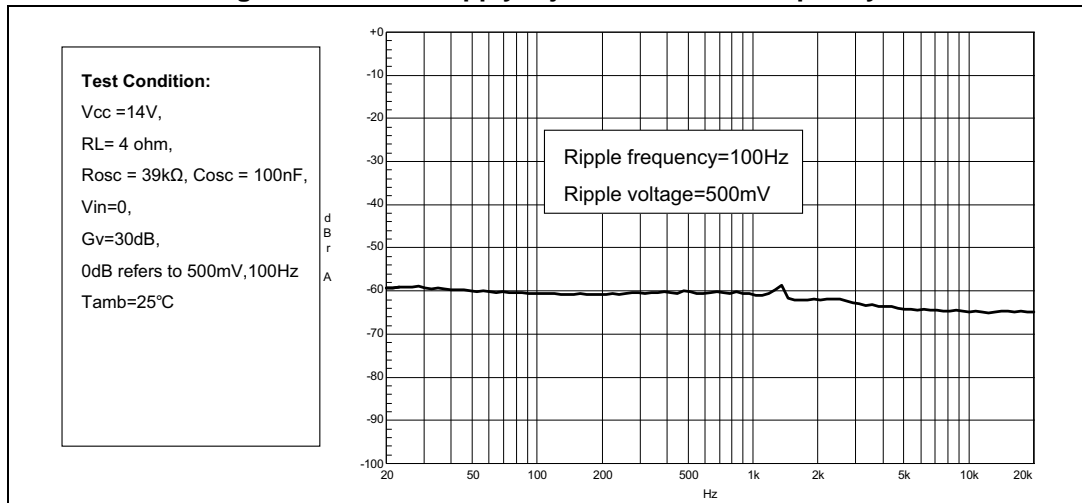

Figure 12. Power dissipation and efficiency vs. output power

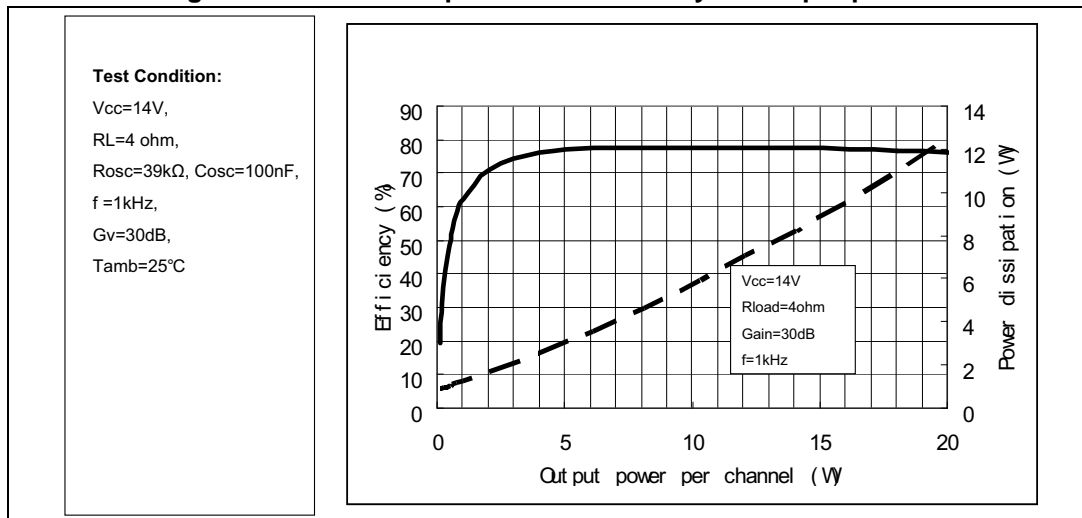

Figure 13. Closed-loop gain vs. frequency

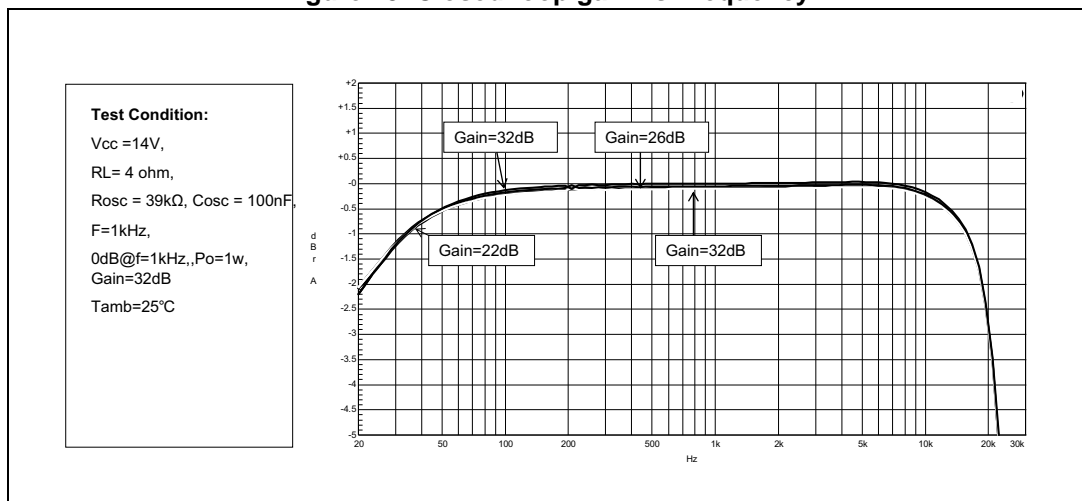

Figure 14. Current consumption vs. voltage on pin MUTE

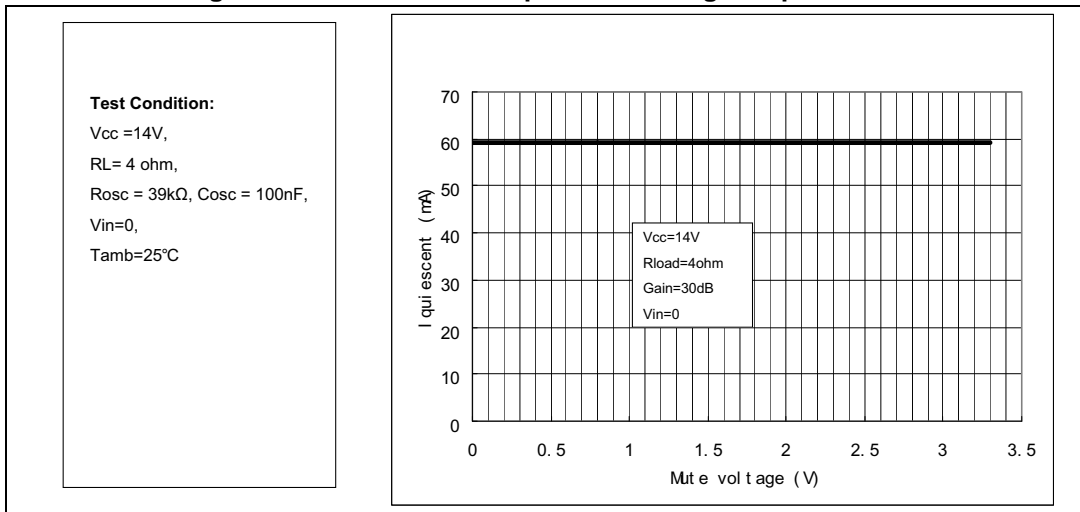

Figure 15. Attenuation vs. voltage on pin MUTE

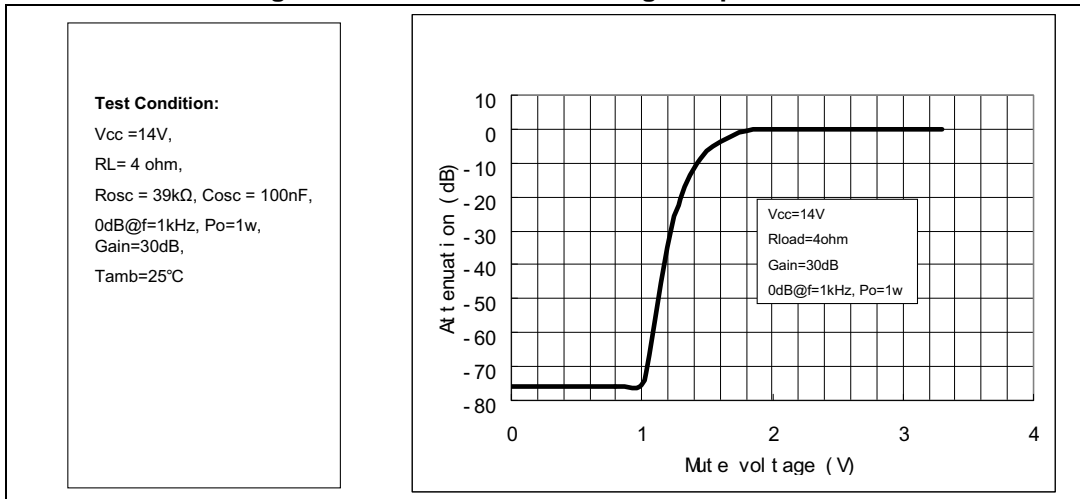

Figure 16. Current consumption vs. voltage on pin STBY

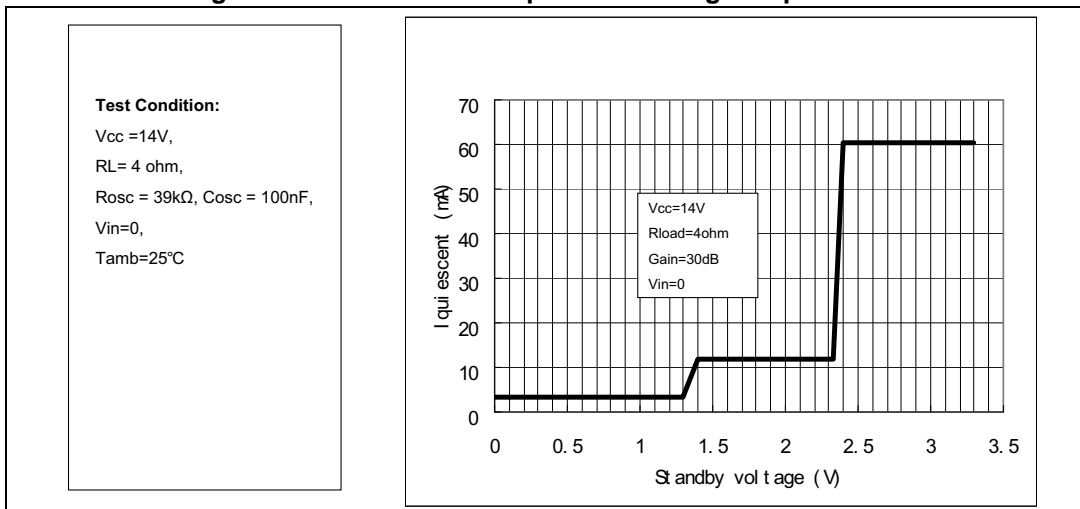
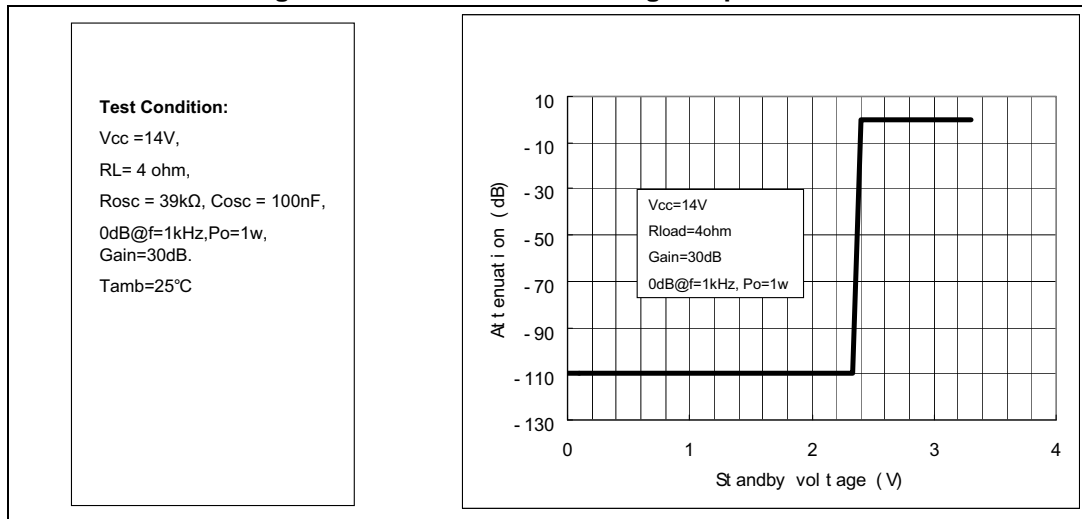

Figure 17. Attenuation vs. voltage on pin STBY



4.2 With 6 Ω load at V_{CC} = 16 V

Figure 18. Output power vs. supply voltage

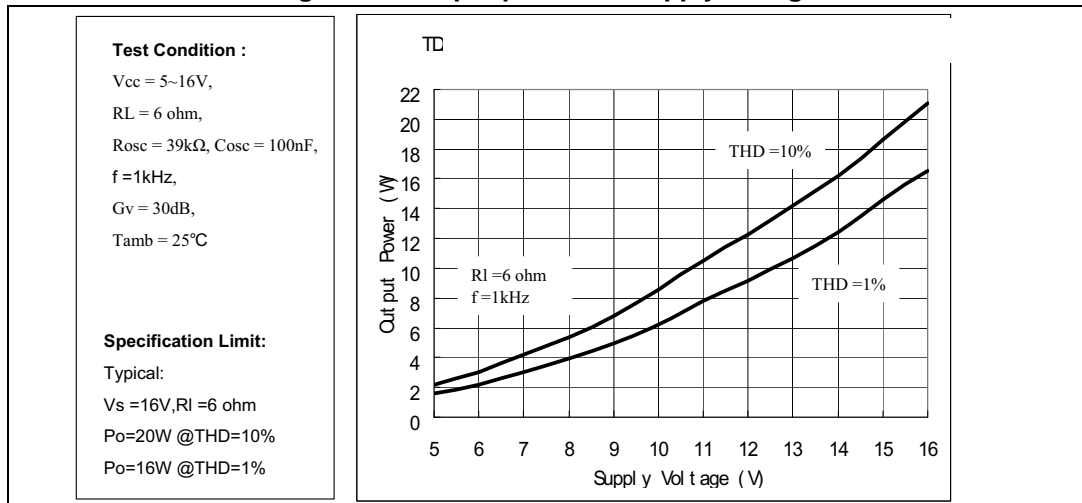

Figure 19. THD vs. output power (1 kHz)

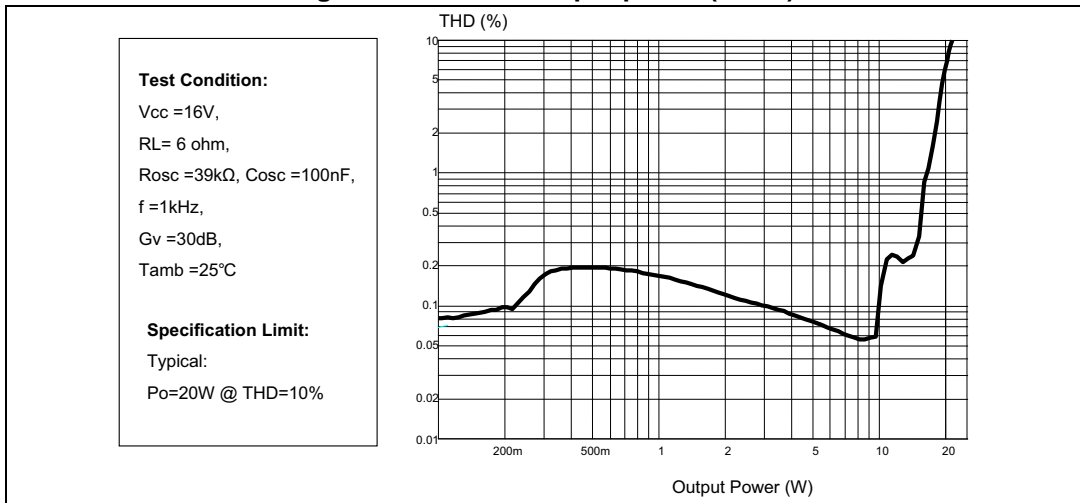

Figure 20. THD vs. output power (100 Hz)

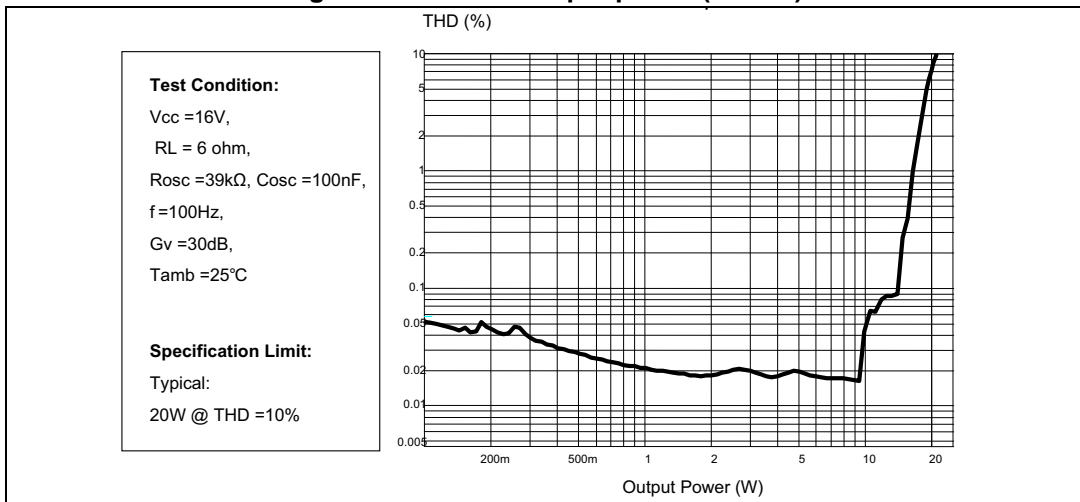

Figure 21. THD vs. frequency

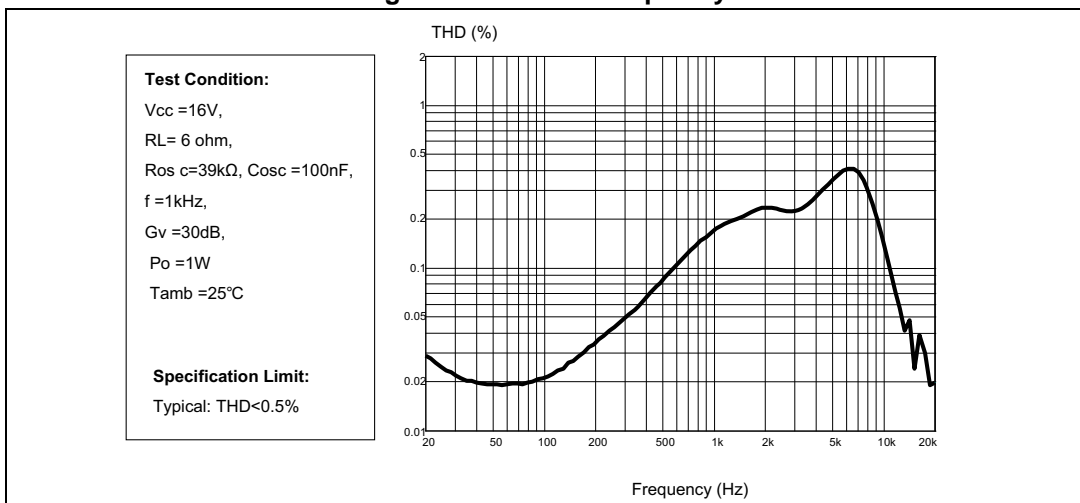

Figure 22. Frequency response

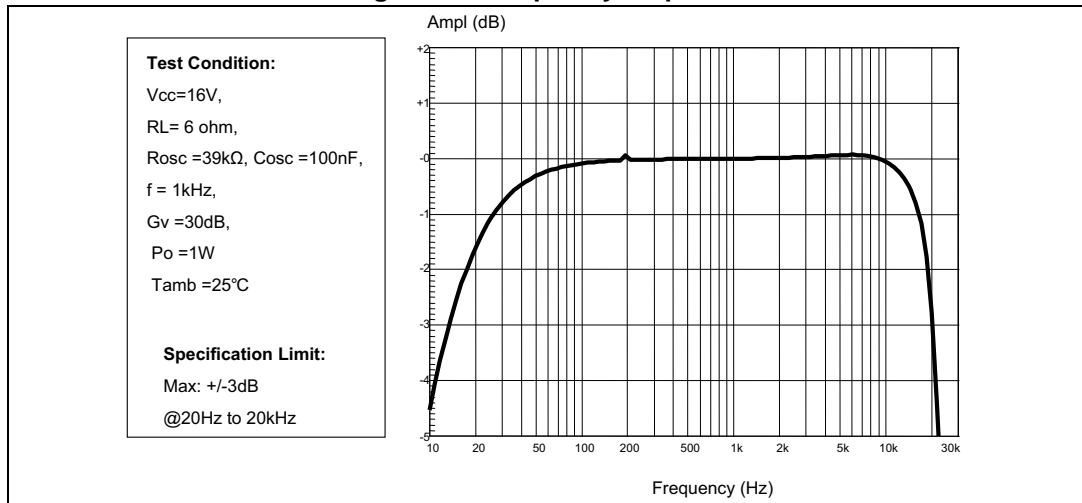

Figure 23. Crosstalk vs. frequency

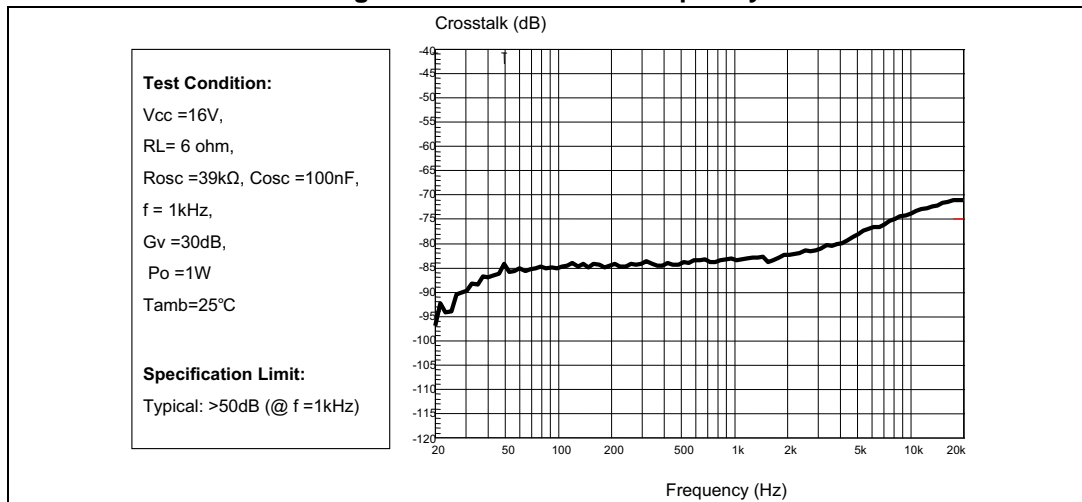

Figure 24. FFT (0 dB)

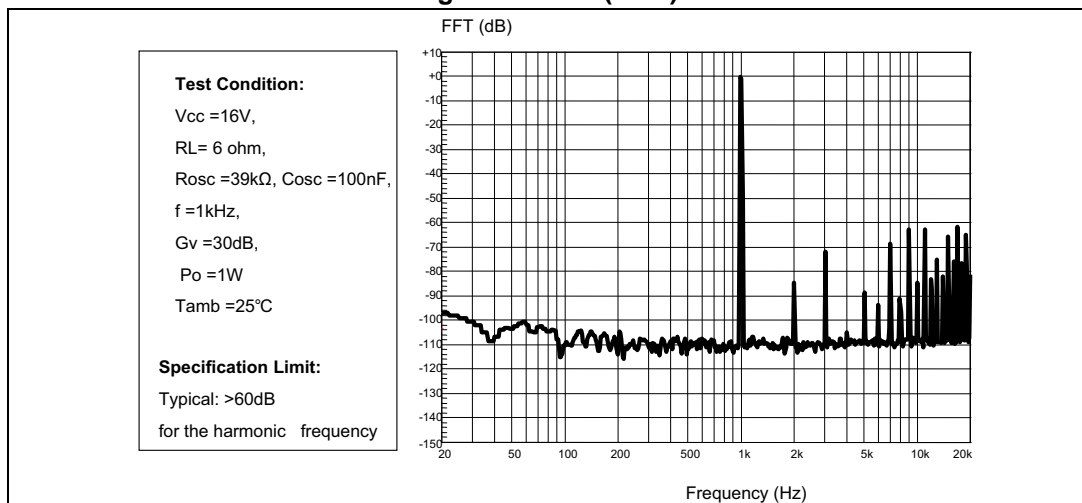

Figure 25. FFT (-60 dB)

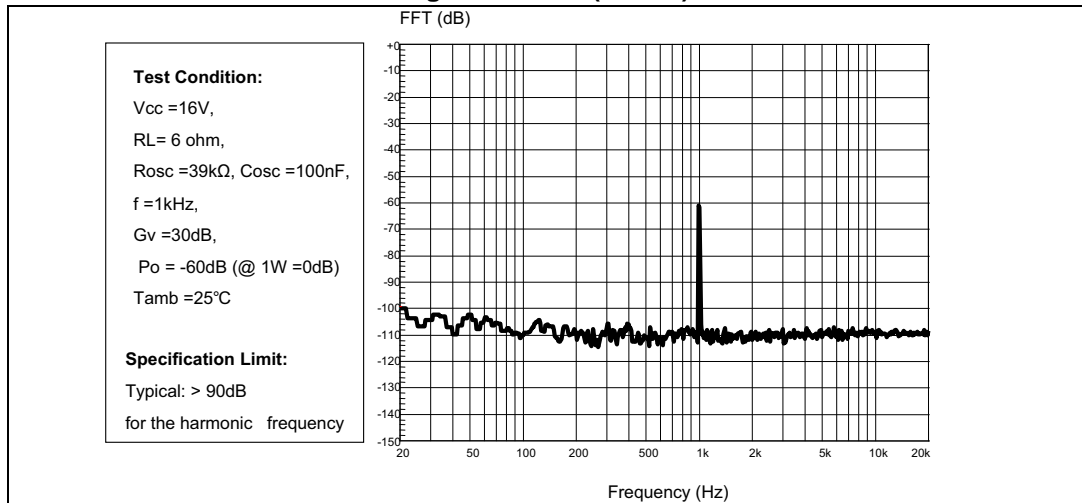

Figure 26. Power supply rejection ratio vs. frequency

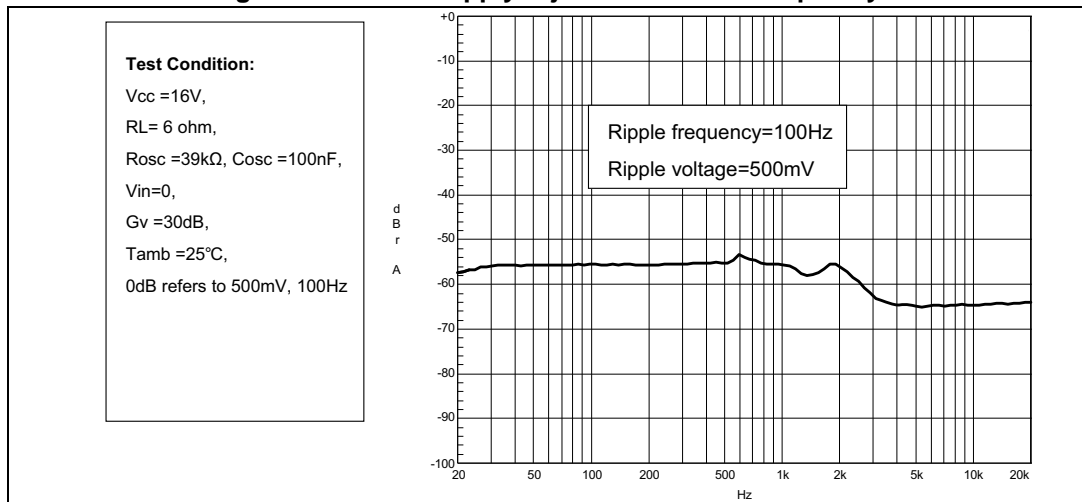

Figure 27. Power dissipation and efficiency vs. output power

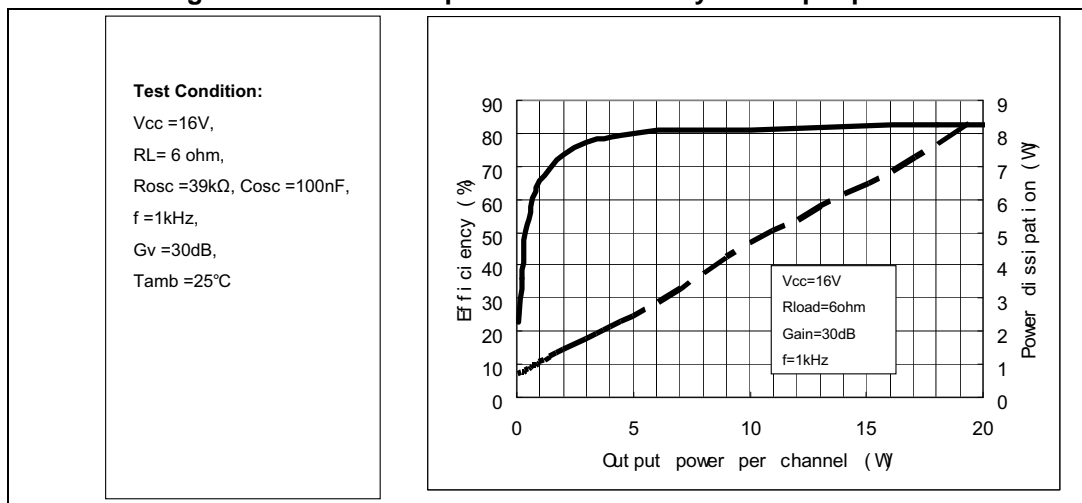

Figure 28. Closed-loop gain vs. frequency

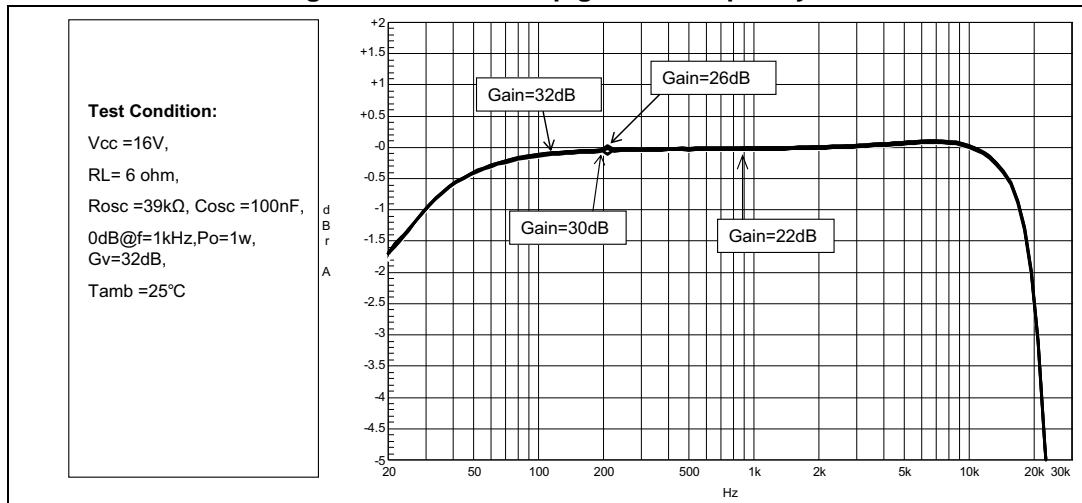

Figure 29. Current consumption vs. voltage on pin MUTE

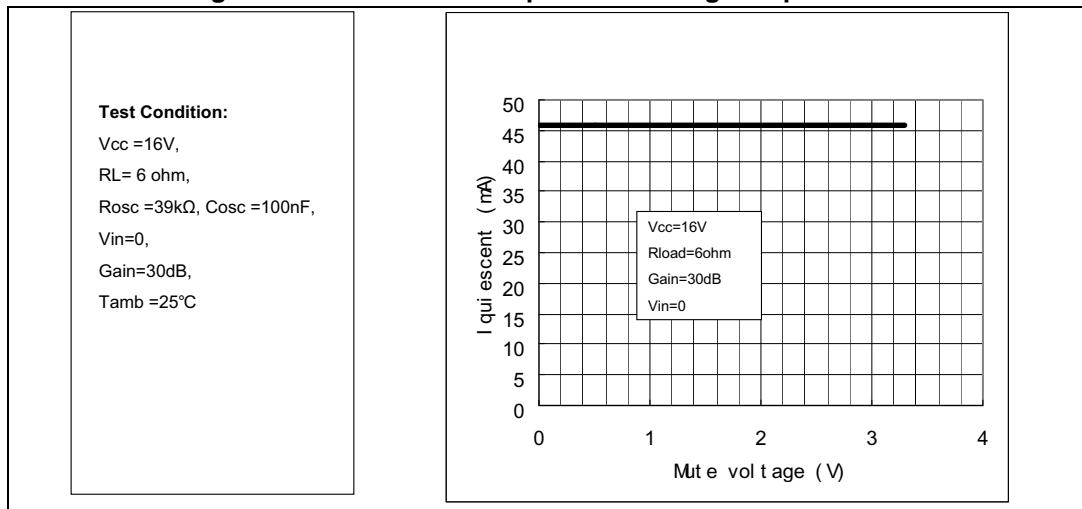

Figure 30. Attenuation vs. voltage on pin MUTE

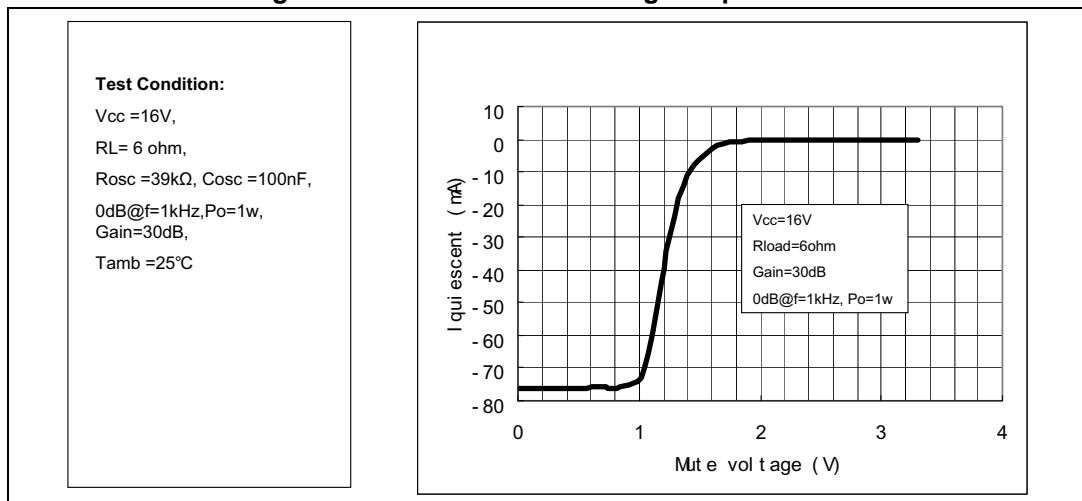

Figure 31. Current consumption vs. voltage on pin STBY

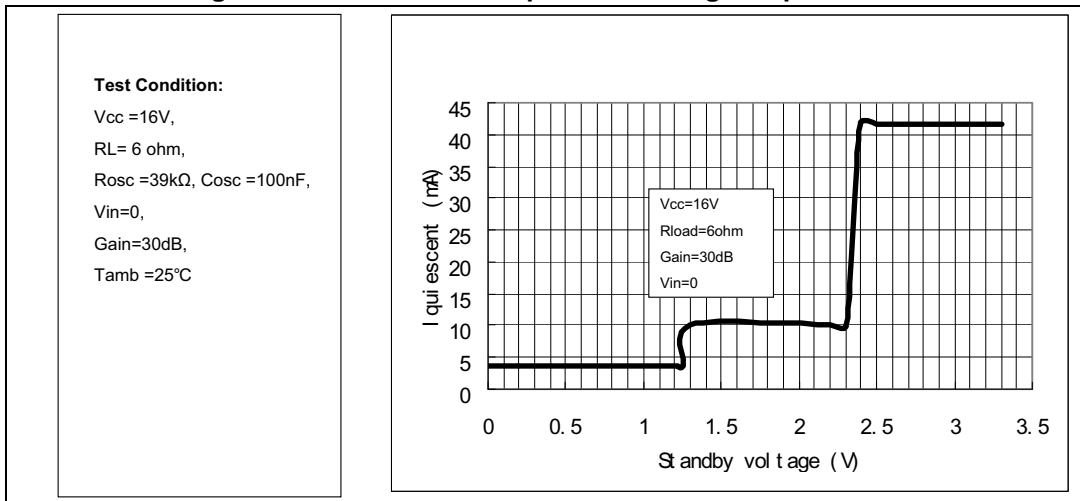
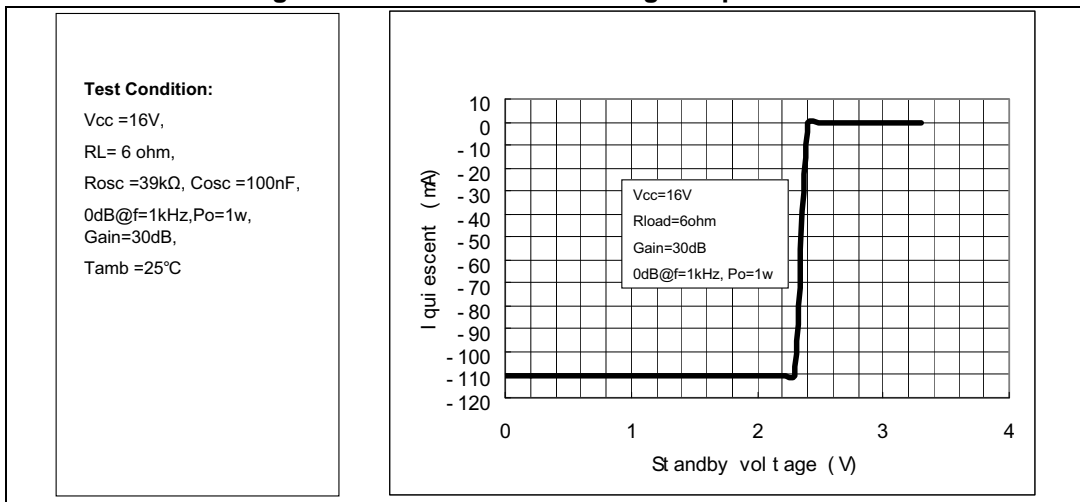

Figure 32. Attenuation vs. voltage on pin STBY



4.3 With 8 Ω load at V_{CC} = 18 V

Figure 33. Output power vs. supply voltage

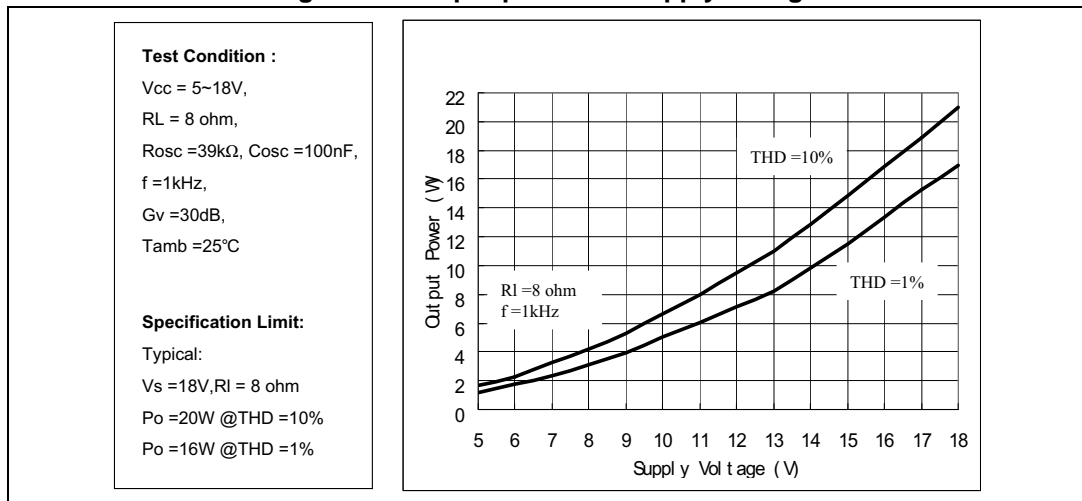

Figure 34. THD vs. output power (1 kHz)

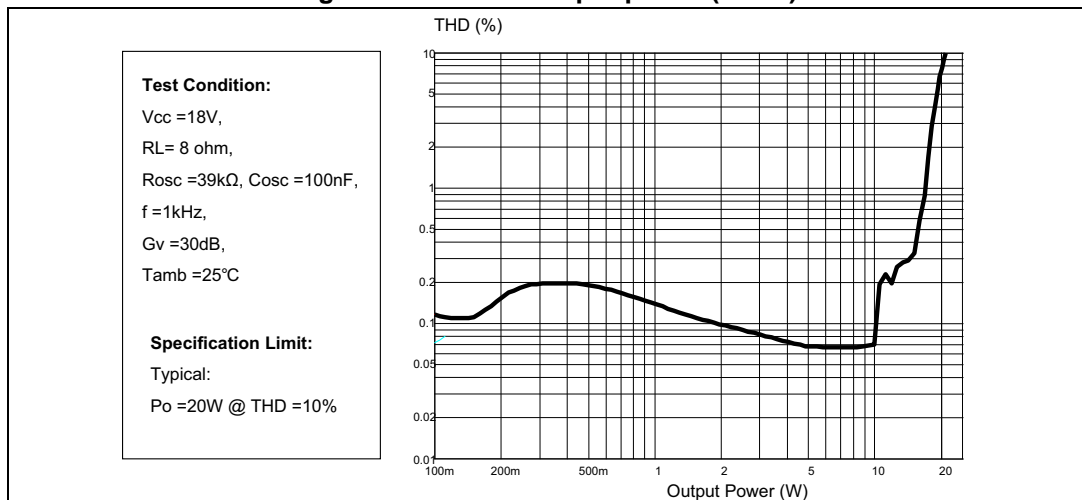

Figure 35. THD vs. output power (100 Hz)

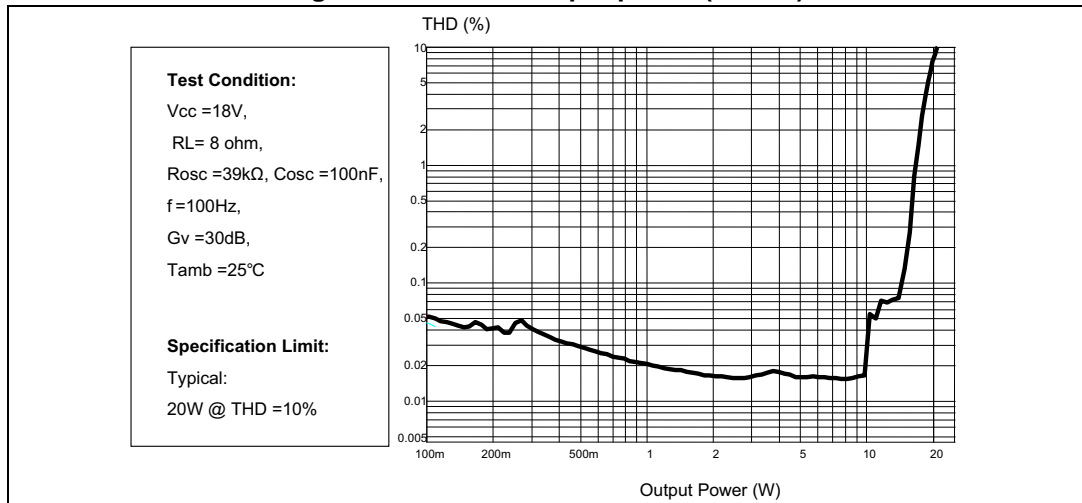

Figure 36. THD vs. frequency

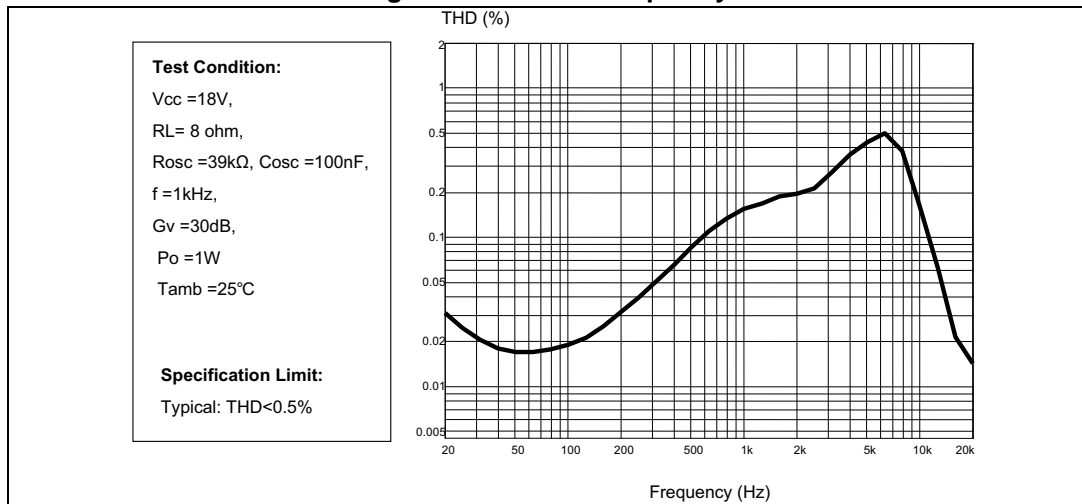

Figure 37. Frequency response

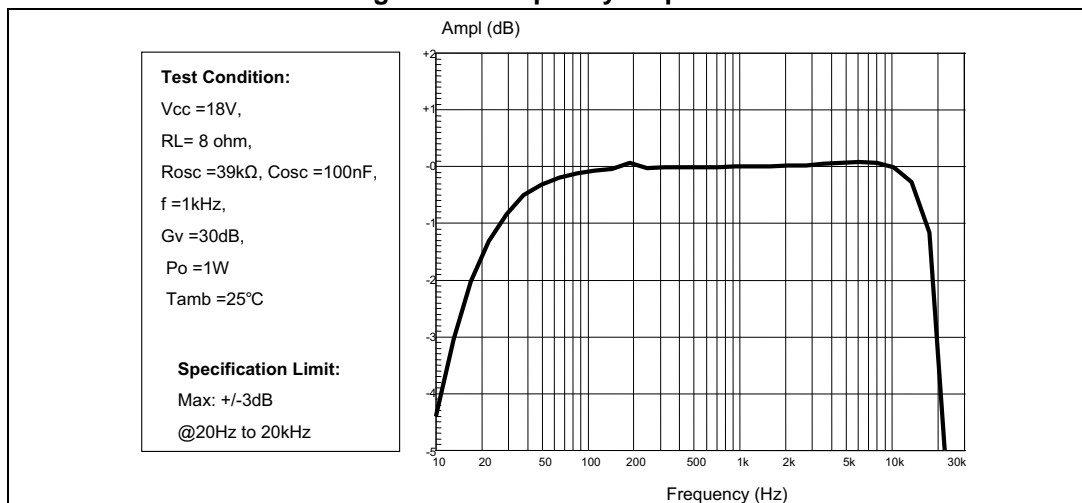

Figure 38. Crosstalk vs. frequency

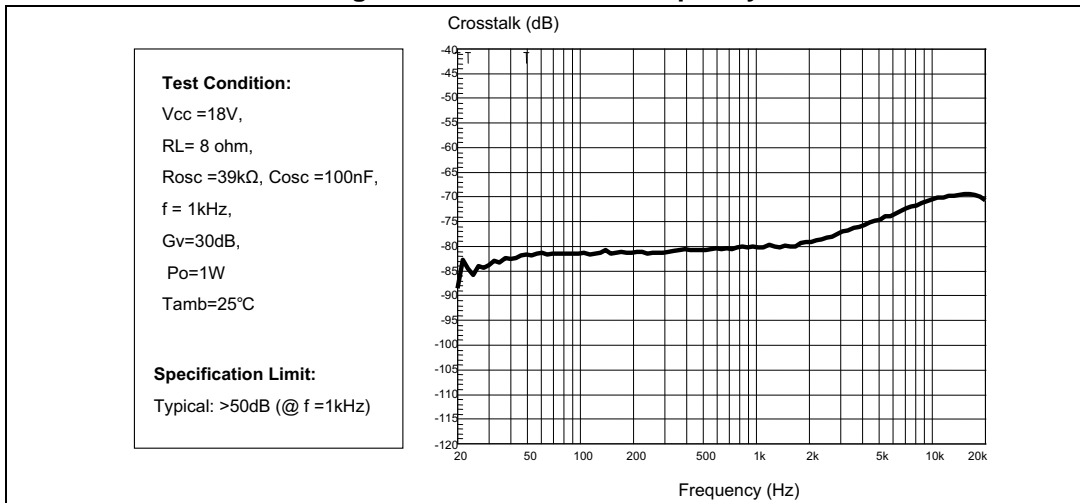

Figure 39. FFT (0 dB)

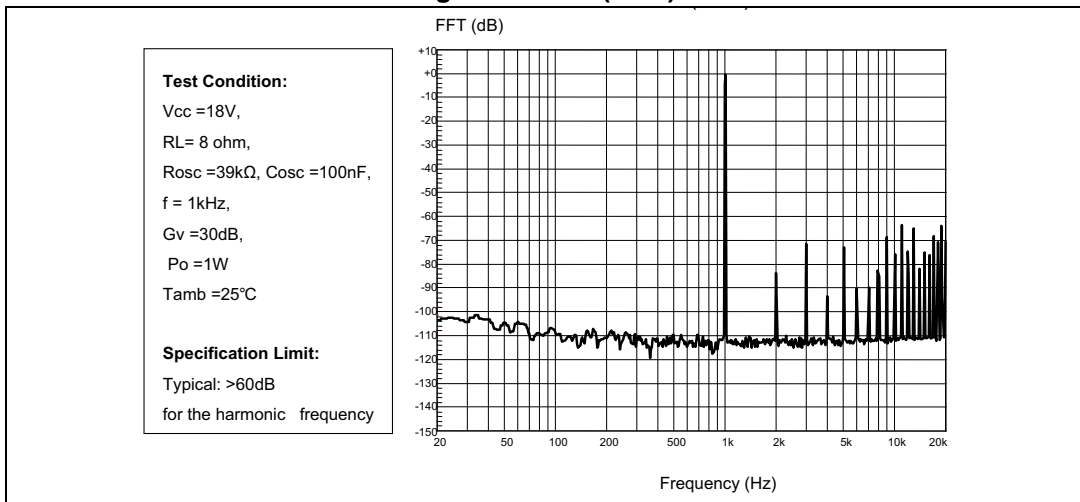

Figure 40. FFT (-60 dB)

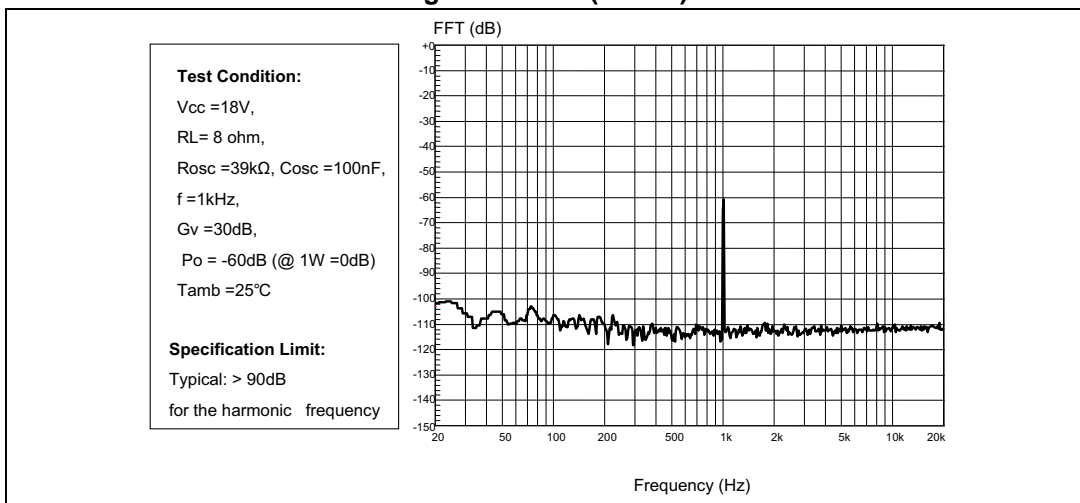

Figure 41. Power supply rejection ratio vs. frequency

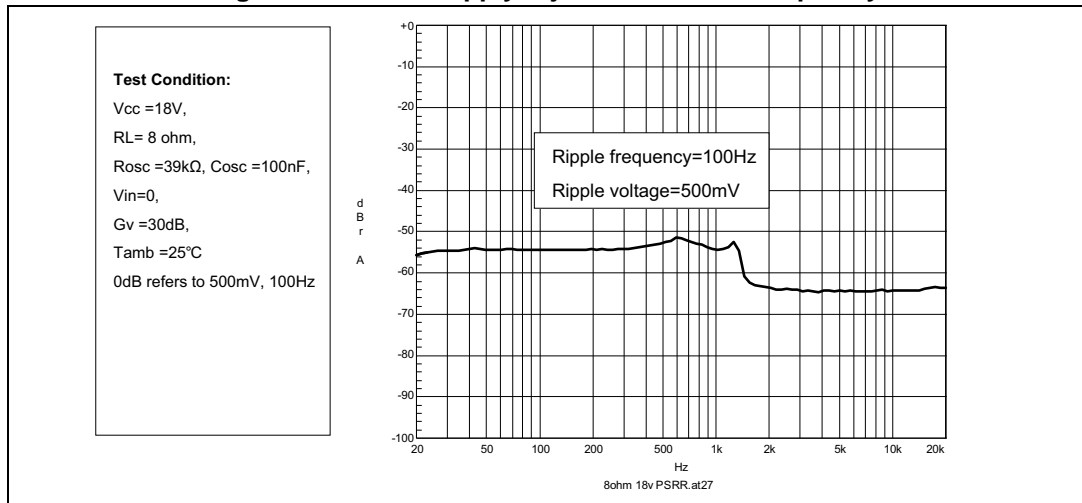

Figure 42. Power dissipation and efficiency vs. output power

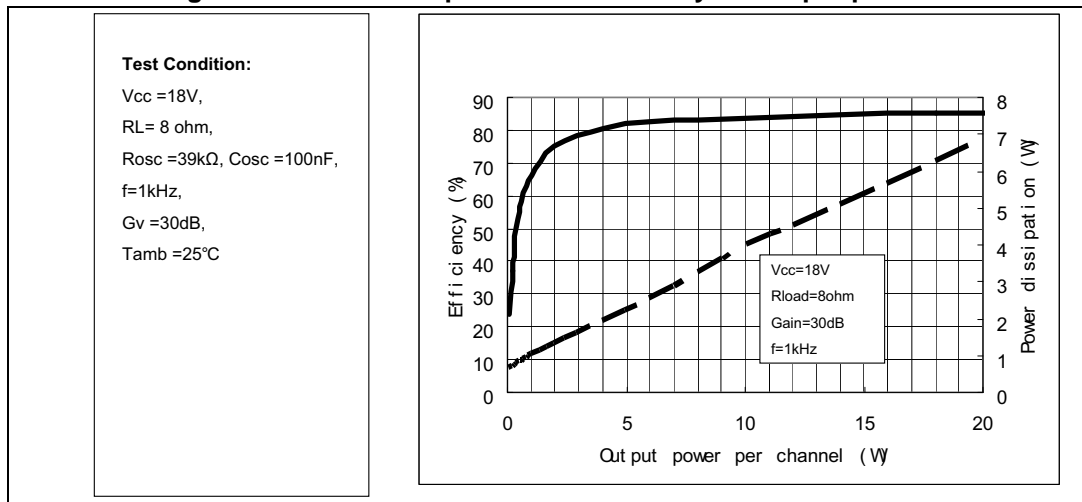

Figure 43. Closed-loop gain vs. frequency

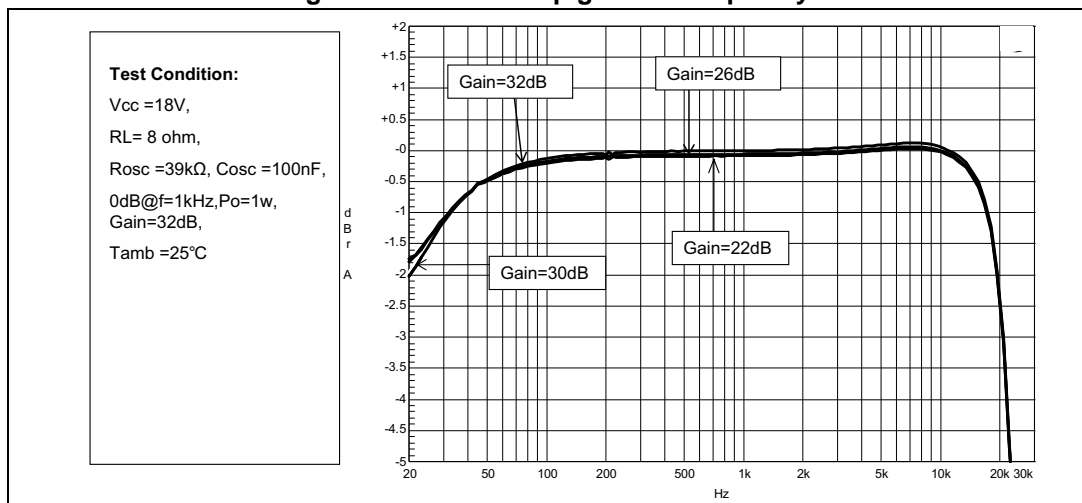

Figure 44. Current consumption vs. voltage on pin MUTE

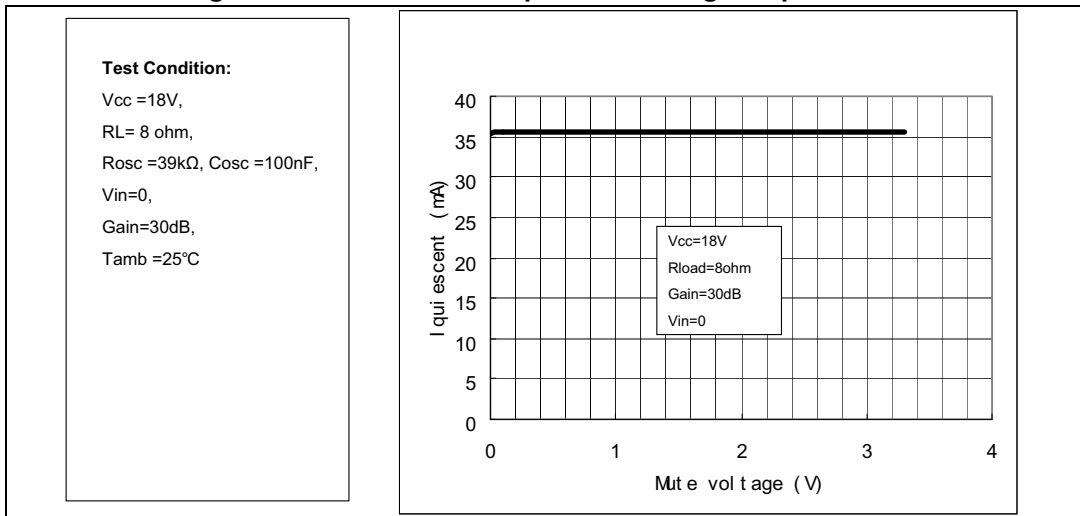

Figure 45. Attenuation vs. voltage on pin MUTE

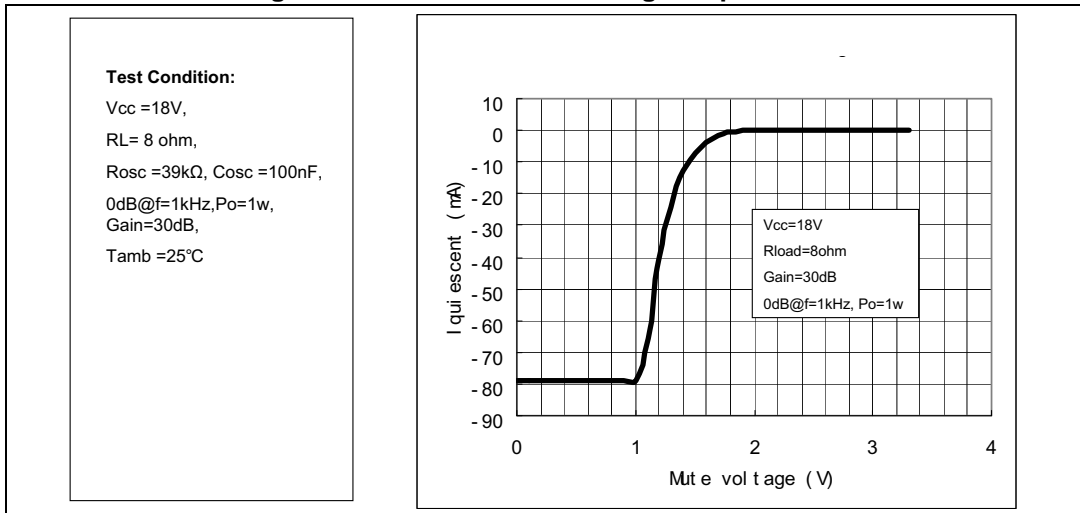

Figure 46. Current consumption vs. voltage on pin STBY

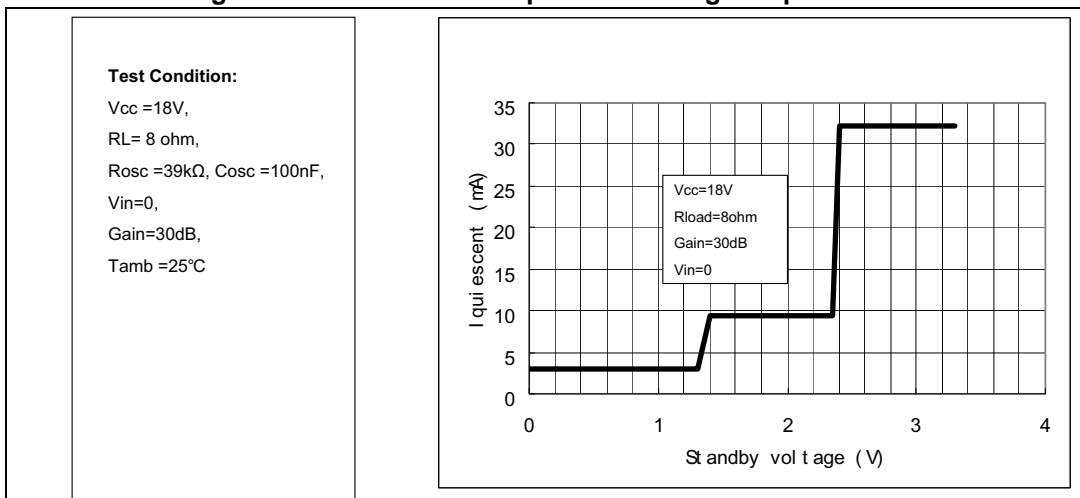
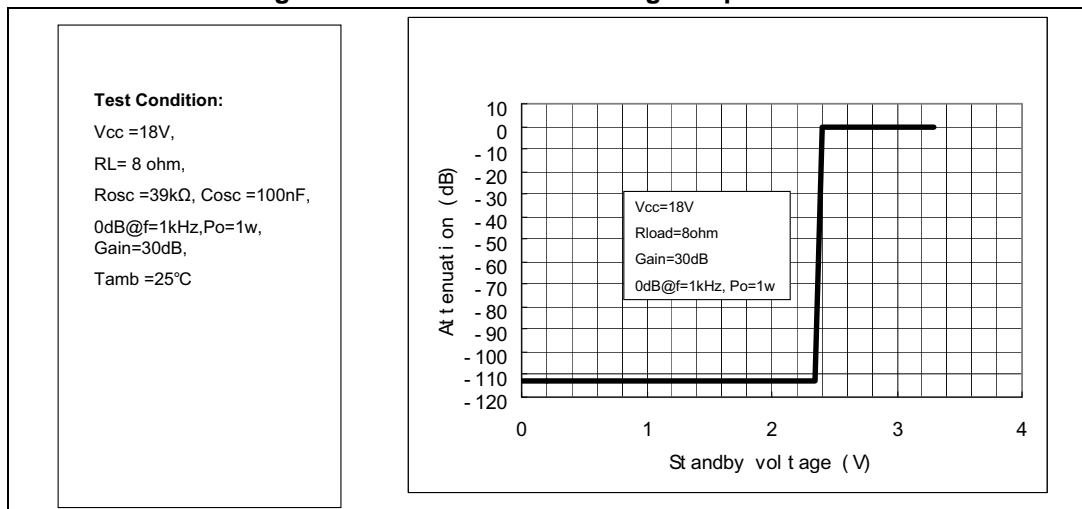
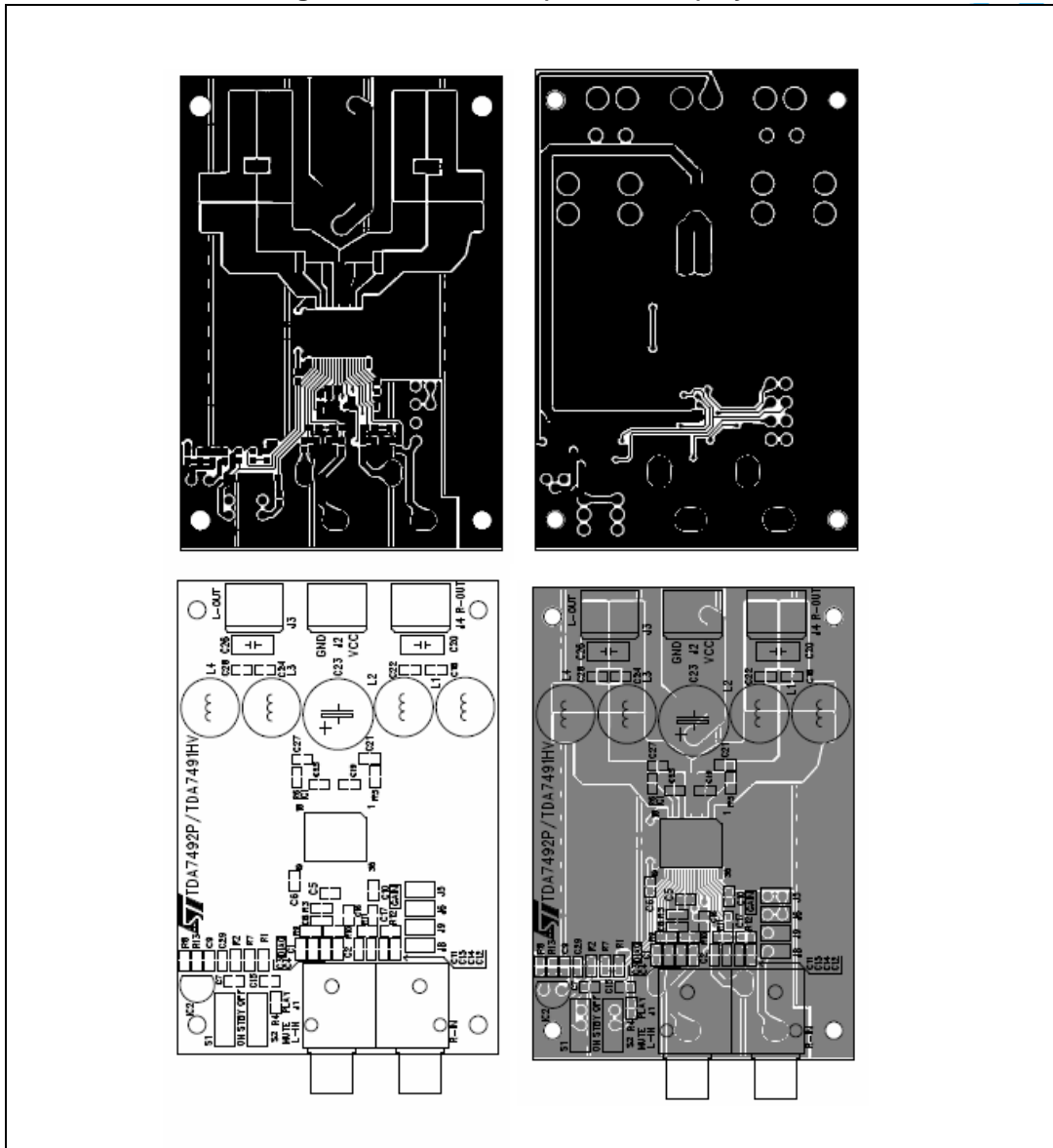

Figure 47. Attenuation vs. voltage on pin STBY



4.4 Test board

Figure 48. Test board (TDA7491HV) layout



5 Package mechanical data

The TDA7491HV comes in a 36-pin PowerSSO package with exposed pad down (EPD).

Figure 49 below shows the package outline and *Table 6* gives the dimensions.

Figure 49. PowerSSO-36 EPD outline drawing

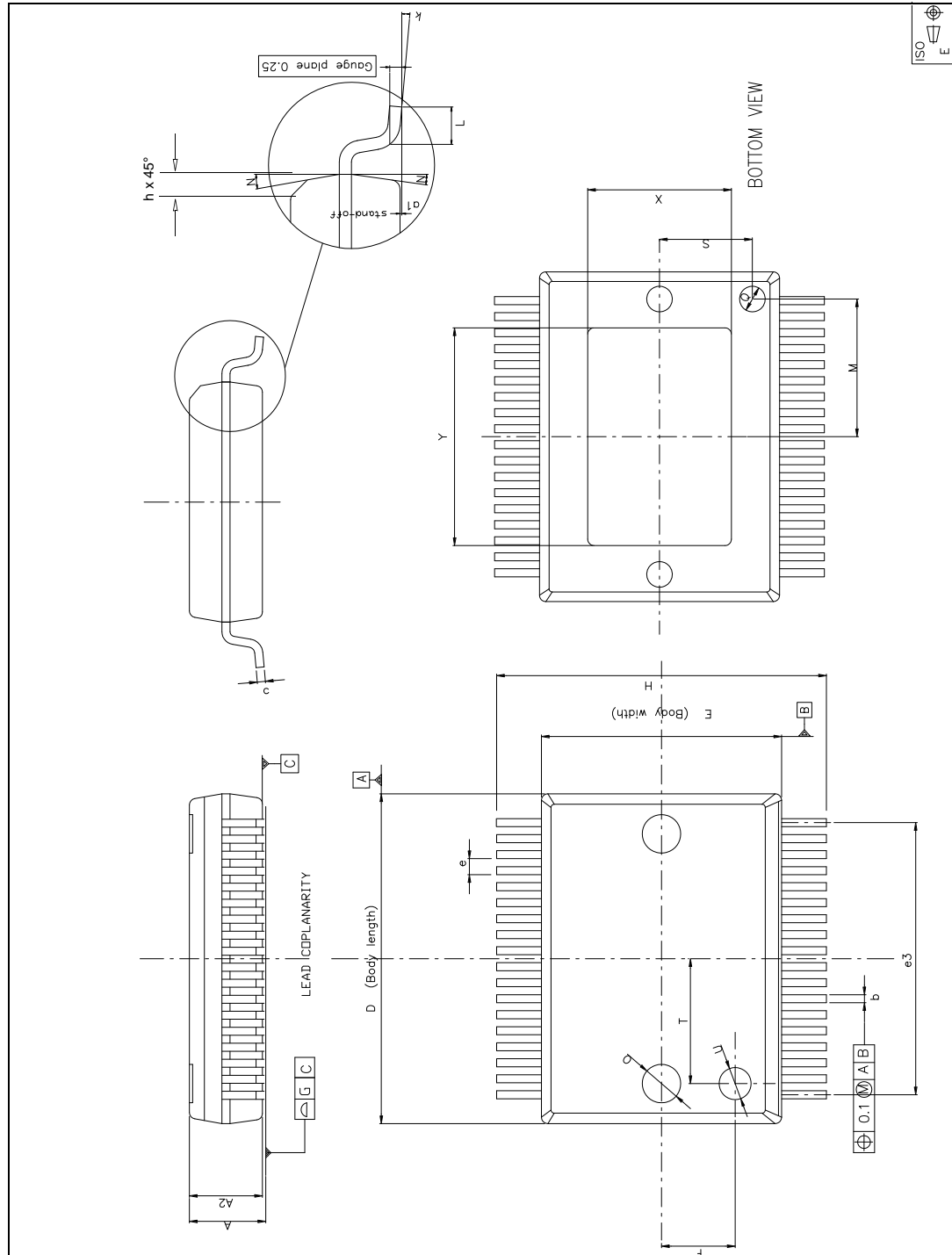

Table 6. PowerSSO-36 EPD dimensions

Symbol	Dimensions in mm			Dimensions in inches		
	Min	Typ	Max	Min	Typ	Max
A	2.15	-	2.47	0.085	-	0.097
A2	2.15	-	2.40	0.085	-	0.094
a1	0.00	-	0.10	0.000	-	0.004
b	0.18	-	0.36	0.007	-	0.014
c	0.23	-	0.32	0.009	-	0.013
D	10.10	-	10.50	0.398	-	0.413
E	7.40	-	7.60	0.291	-	0.299
e	-	0.5	-	-	0.020	-
e3	-	8.5	-	-	0.335	-
F	-	2.3	-	-	0.091	-
G	-	-	0.10	-	-	0.004
H	10.10	-	10.50	0.398	-	0.413
h	-	-	0.40	-	-	0.016
k	0	-	8 degrees	0	-	8 degrees
L	0.60	-	1.00	0.024	-	0.039
M	-	4.30	-	-	0.169	-
N	-	-	10 degrees	-	-	10 degrees
O	-	1.20	-	-	0.047	-
Q	-	0.80	-	-	0.031	-
S	-	2.90	-	-	0.114	-
T	-	3.65	-	-	0.144	-
U	-	1.00	-	-	0.039	-
X	4.10	-	4.70	0.161	-	0.185
Y	4.90	-	7.10	0.193	-	0.280

In order to meet environmental requirements, ST offers these devices in different grades of ECOPACK[®] packages, depending on their level of environmental compliance. ECOPACK[®] specifications, grade definitions and product status are available at: www.st.com. ECOPACK[®] is an ST trademark.

6 Applications circuit

Figure 50. Applications circuit for class-D amplifier

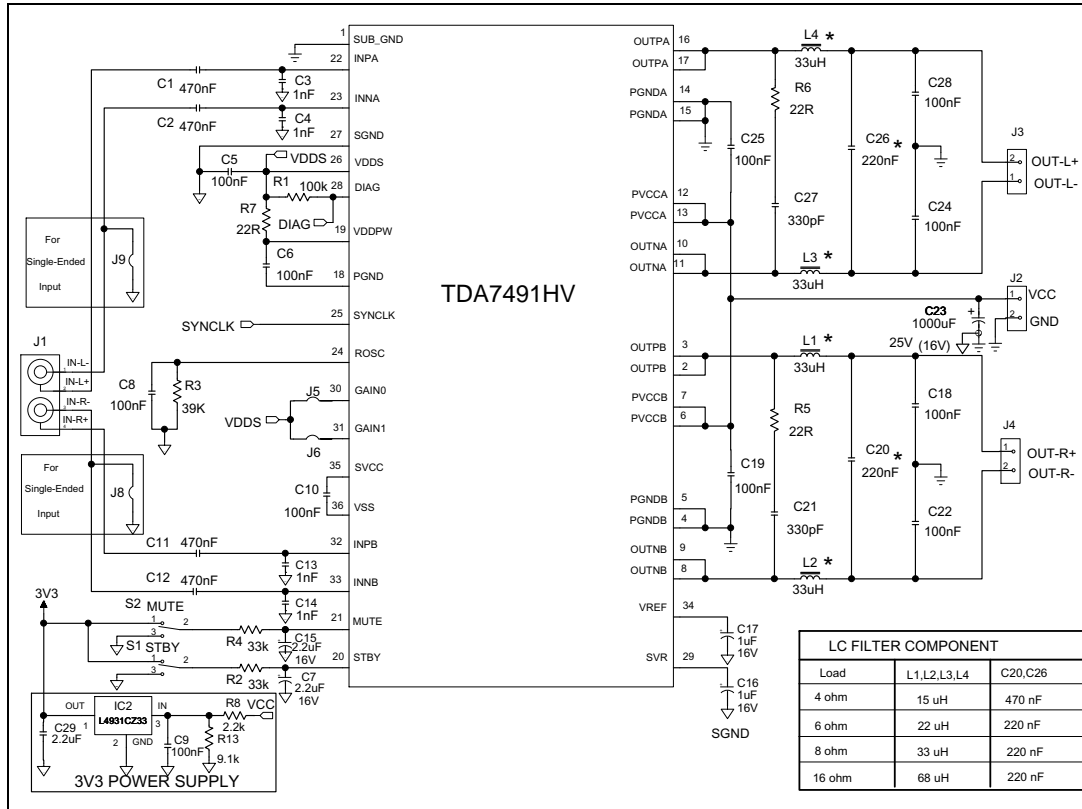

7 Application information

7.1 Mode selection

The three operating modes, defined below, of the TDA7491HV are set by the two inputs STBY (pin 20) and MUTE (pin 21) as shown in [Table 7: Mode settings on page 33](#).

- Standby mode: all circuits are turned off, very low current consumption.
- Mute mode: inputs are connected to ground and the positive and negative PWM outputs are at 50% duty cycle.
- Play mode: the amplifiers are active.

The protection functions of the TDA7491HV are implemented by pulling down the voltages of the STBY and MUTE inputs shown in [Figure 51](#). The input current of the corresponding pins must be limited to 200 μ A.

Table 7. Mode settings

Mode	Voltage level on pin STBY	Voltage level on pin MUTE
Standby	L ⁽¹⁾	X (don't care)
Mute	H ⁽¹⁾	L
Play	H	H

1. refer to VSTBY and VMUTE in [Table 5: Electrical specifications on page 10](#)

Figure 51. Standby and mute circuits

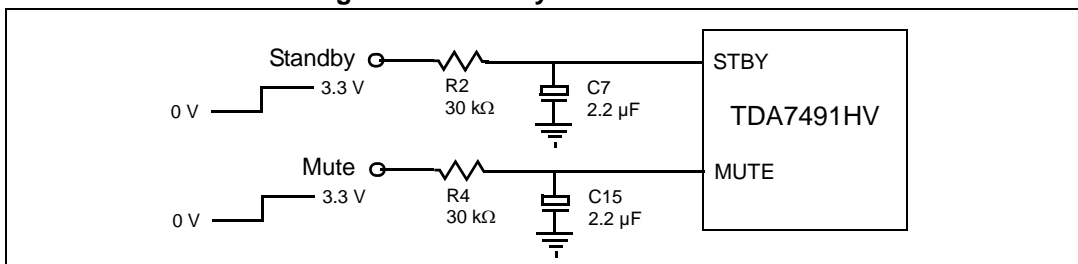
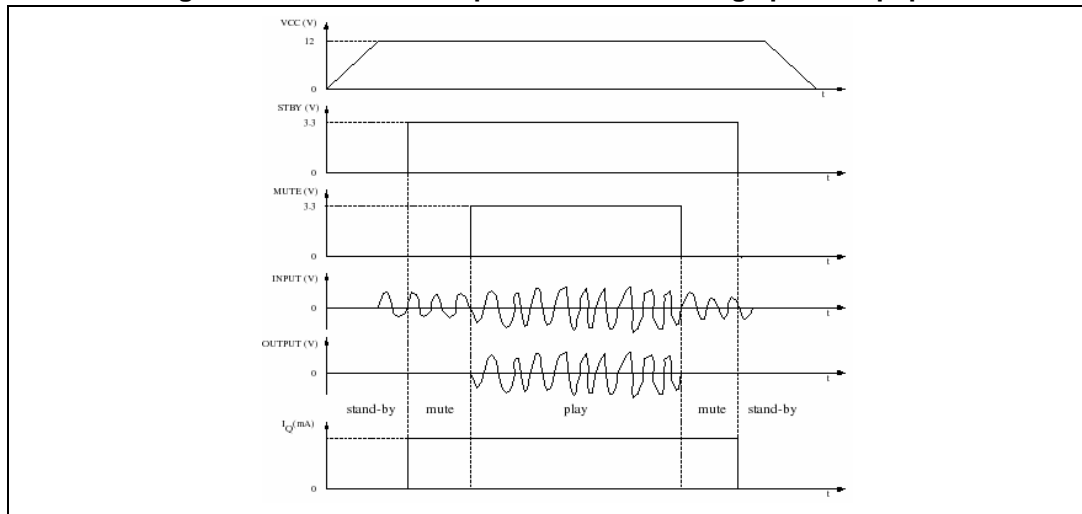

Figure 52. Turn-on/off sequence for minimizing speaker “pop”



7.2 Gain setting

The gain of the TDA7491HV is set by the two inputs, GAIN0 (pin 30) and GAIN1 (pin 31). Internally, the gain is set by changing the feedback resistors of the amplifier.

Table 8. Gain settings

GAIN0	GAIN1	Nominal gain, G_v (dB)
L(1)	H(1)	20
L	H	26
H	L	30
H	H	32

1. Refer to V_{inL} and V_{inH} in [Table 5: Electrical specifications on page 10](#) for drive levels for L and H

7.3 Input resistance and capacitance

The input impedance is set by an internal resistor $R_i = 68\text{ k}\Omega$ (typical). An input capacitor (C_i) is required to couple the AC input signal.

The equivalent circuit and frequency response of the input components are shown in [Figure 53](#). For $C_i = 220\text{ nF}$ the high-pass filter cutoff frequency is below 20 Hz:

$$f_c = 1 / (2 * \pi * R_i * C_i)$$

Figure 53. Device input circuit and frequency response

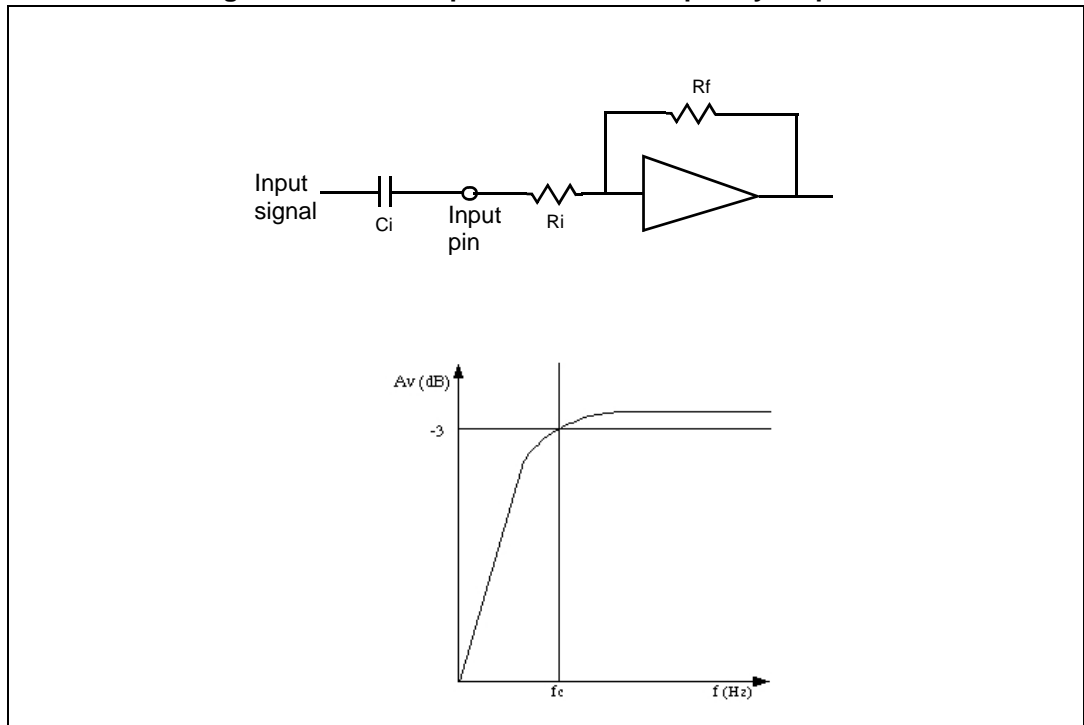

7.4 Internal and external clocks

The clock of the class-D amplifier can be generated internally or can be driven by an external source.

If two or more class-D amplifiers are used in the same system, it is recommended that all devices operate at the same clock frequency. This can be implemented by using one TDA7491HV as master clock, while the other devices are in slave mode (that is, externally clocked). The clock interconnect is via pin SYNCLK of each device. As explained below, SYNCLK is an output in master mode and an input in slave mode.

7.4.1 Master mode (internal clock)

Using the internal oscillator, the output switching frequency, f_{SW} , is controlled by the resistor, R_{OSC} , connected to pin ROSC:

$$f_{SW} = 10^6 / ((16 * R_{OSC} + 182) * 4) \text{ kHz}$$

where R_{OSC} is in $k\Omega$.

In master mode, pin SYNCLK is used as a clock output pin, whose frequency is:

$$f_{SYNCLK} = 2 * f_{SW}$$

For master mode to operate correctly then resistor R_{OSC} must be less than 60 $k\Omega$ as given below in [Table 9](#).

7.4.2 Slave mode (external clock)

In order to accept an external clock input the pin ROSC must be left open, that is, floating. This forces pin SYNCLK to be internally configured as an input as given in [Table 9](#).

The output switching frequency of the slave devices is:

$$f_{SW} = f_{SYNCLK} / 2$$

Table 9. How to set up SYNCLK

Mode	ROSC	SYNCLK
Master	$R_{OSC} < 60 \text{ k}\Omega$	Output
Slave	Floating (not connected)	Input

Figure 54. Master and slave connection

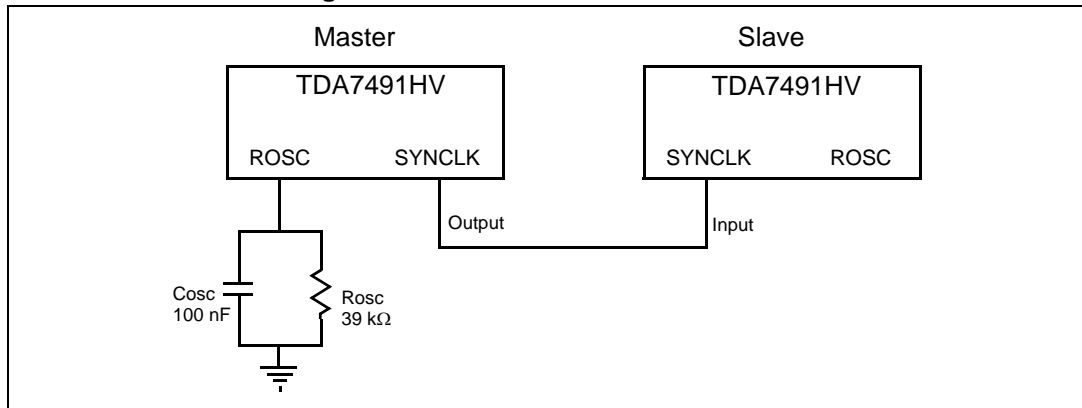

7.5 Modulation

The output modulation scheme of the BTL is called unipolar pulse width modulation (PWM). The differential output voltages change between 0 V and $+V_{CC}$ and between 0 V and $-V_{CC}$. This is in contrast to the traditional bipolar PWM outputs which change between $+V_{CC}$ and $-V_{CC}$.

An advantage of this scheme is that it effectively doubles the switching frequency of the differential output waveform on the load then reducing the current ripple accordingly. The OUTP and OUTN are in the same phase almost overlapped when the input is zero under this condition, then the switching current is low and the related losses in the load are low.

In practice, a short delay is introduced between these two outputs in order to avoid the BTL output switching simultaneously when the input is zero.

Figure 55 shows the resulting differential output voltage and current when a positive, zero and negative input signal is applied. The resulting differential voltage on the load has a double frequency with respect to outputs OUTP and OUTN, resulting in reduced current ripple.

Figure 55. Unipolar PWM output

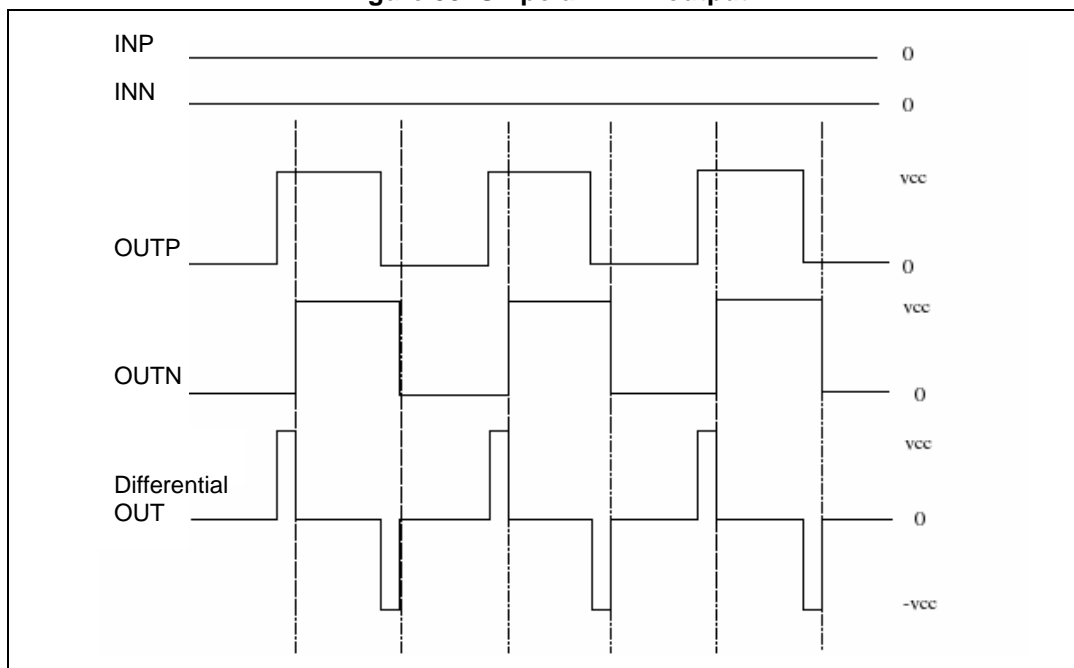

7.6 Reconstruction low-pass filter

Standard applications use a low-pass filter before the speaker. The cutoff frequency should be higher than 22 kHz and much lower than the output switching frequency. It is necessary to choose the L-C component values depending on the loud speaker impedance. Some typical values, which give a cutoff frequency of 27 kHz, are shown in [Figure 56](#) and [Figure 57](#) below.

Figure 56. Typical LC filter for an 8 Ω speaker

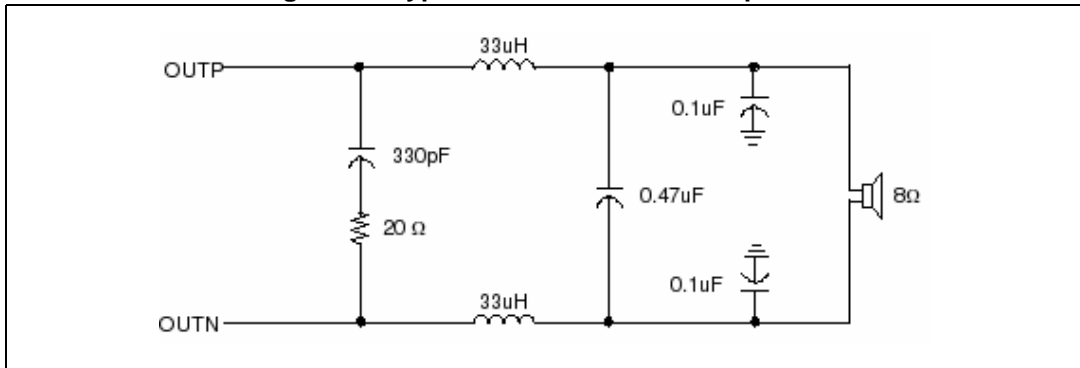
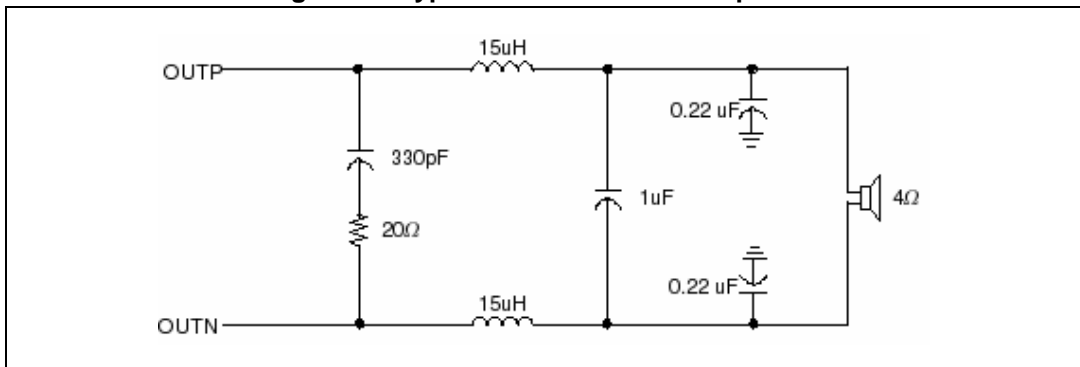

Figure 57. Typical LC filter for a 4 Ω speaker



7.7 Protection functions

The TDA7491HV is fully protected against undervoltage, overcurrent and thermal overloads as explained here.

Undervoltage protection (UVP)

If the supply voltage drops below the value of V_{UVP} given in [Table 5: Electrical specifications on page 10](#) the undervoltage protection is activated which forces the outputs to the high-impedance state. When the supply voltage recovers the device restarts.

Overcurrent protection (OCP)

If the output current exceeds the value for I_{OCP} given in [Table 5: Electrical specifications on page 10](#) the overcurrent protection is activated which forces the outputs to the high-impedance state. Periodically, the device attempts to restart. If the overcurrent condition is still present then the OCP remains active. The restart time, T_{OC} , is determined by the R-C components connected to pin STBY.

Thermal protection (OTP)

If the junction temperature, T_j , reaches 145 °C (nominal), the device goes to mute mode and the positive and negative PWM outputs are forced to 50% duty cycle. If the junction temperature reaches the value for T_j , given in [Table 5: Electrical specifications on page 10](#) the device shuts down and the output is forced to the high-impedance state. When the device cools sufficiently the device restarts.

7.8 Diagnostic output

The output pin DIAG is an open-drain transistor. When the protection is activated it is in the high-impedance state. The pin can be connected to a power supply (<18 V) by a pull-up resistor whose value is limited by the maximum sinking current (200 μ A) of the pin.

Figure 58. Behavior of pin DIAG for various protection conditions

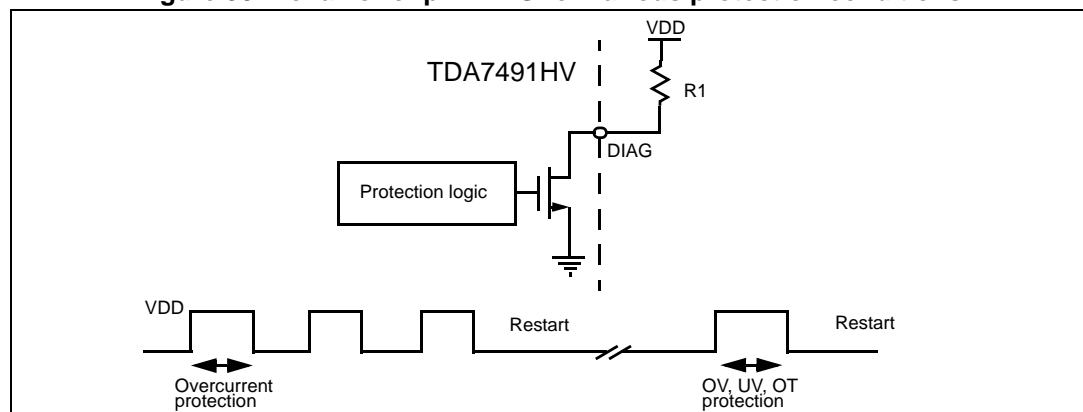

7.9 Heatsink requirements

Due to the high efficiency of the class-D amplifier a 2-layer PCB can easily provide the heatsinking capability for low to medium power outputs.

Using such a PCB with a copper ground layer of 3x3 cm² and 16 vias connecting it to the contact area for the exposed pad, a thermal resistance, junction to ambient (in natural air convection), of 24 °C/W can be achieved.

The dissipated power within the device depends primarily on the supply voltage, load impedance and output modulation level. With the TDA7491HV driving 2 x 8 Ω with a supply of 18 V then the device dissipation is approximately 4 W that gives with the above mentioned PCB a junction temperature increase of about 90 °C.

With a musical program the dissipated power is about 40% less than the above maximum value. This leads to a junction temperature increase of around 60 °C. So even at the maximum recommended ambient temperature there is a margin of safety before the maximum junction temperature is reached.

Figure 59 shows the derating curves for copper areas of 4 cm² and 9 cm².

Figure 59. Power derating curves for PCB used as heatsink

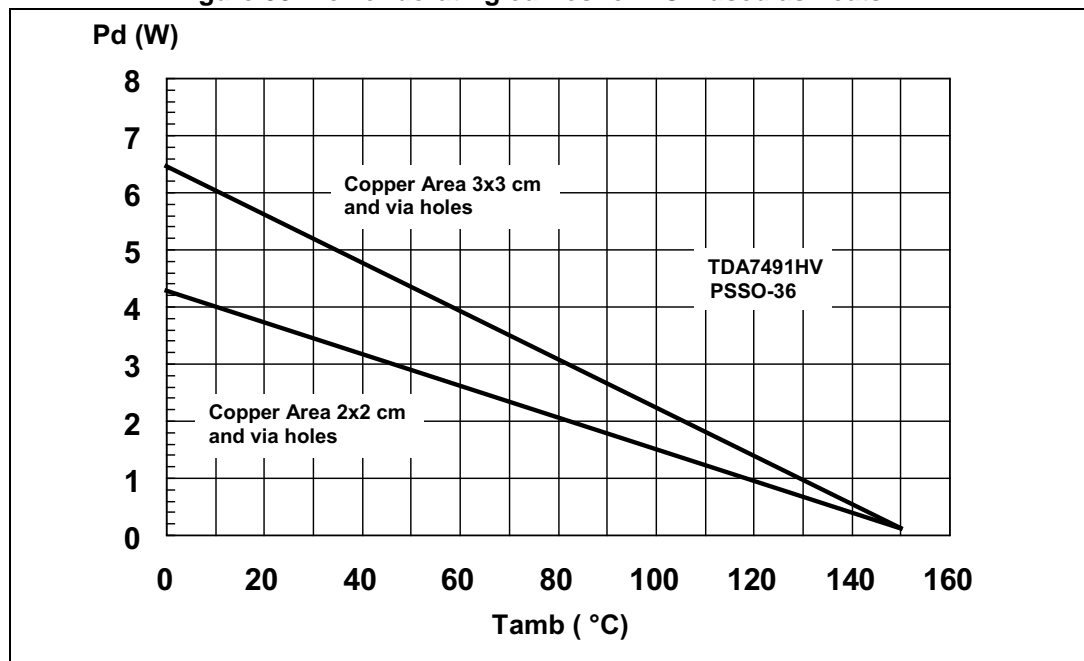

8 Revision history

Table 10. Document revision history

Date	Revision	Changes
02-Jul-2007	1	Initial release.
03-Oct-2008	2	Updated AMR table Updated Chapter 4: Characterization curves on page 12 Added Figure 48: Test board (TDA7491HV) layout on page 29 Updated Figure 49: PowerSSO-36 EPD outline drawing on page 30 and Table 6: PowerSSO-36 EPD dimensions on page 31 Updated Figure 50: Applications circuit for class-D amplifier on page 32
29-Jun-2009	3	Updated text concerning oscillator R and C in Section 3.3: Electrical specifications on page 10 Updated VOVP minimum value, added VUVP maximum value, updated STBY and MUTE voltages in Table 5: Electrical specifications on page 10 Updated equation for f_{SW} Table 5 on page 10 Updated Figure 50: Applications circuit for class-D amplifier on page 32
03-Sep-2009	4	Added text for exposed pad in Figure 2 on page 8 Added text for exposed pad in Table 2 on page 9 Updated exposed pad Y (Min) dimension in Table 6 on page 31 Updated supply voltage for pin DIAG pull-up resistor in Section 7.8 on page 40 .
24-Mar-2011	5	Updated Features Updated Section 3: Electrical specifications Removed filter less operation Extended the temperature range to -40 to +85°C.
12-Sep-2011	6	Updated OUTNA in Table 2: Pin description list
20-Feb-2014	7	Updated order code Table 1 on page 1

Please Read Carefully:

Information in this document is provided solely in connection with ST products. STMicroelectronics NV and its subsidiaries ("ST") reserve the right to make changes, corrections, modifications or improvements, to this document, and the products and services described herein at any time, without notice.

All ST products are sold pursuant to ST's terms and conditions of sale.

Purchasers are solely responsible for the choice, selection and use of the ST products and services described herein, and ST assumes no liability whatsoever relating to the choice, selection or use of the ST products and services described herein.

No license, express or implied, by estoppel or otherwise, to any intellectual property rights is granted under this document. If any part of this document refers to any third party products or services it shall not be deemed a license grant by ST for the use of such third party products or services, or any intellectual property contained therein or considered as a warranty covering the use in any manner whatsoever of such third party products or services or any intellectual property contained therein.

UNLESS OTHERWISE SET FORTH IN ST'S TERMS AND CONDITIONS OF SALE ST DISCLAIMS ANY EXPRESS OR IMPLIED WARRANTY WITH RESPECT TO THE USE AND/OR SALE OF ST PRODUCTS INCLUDING WITHOUT LIMITATION IMPLIED WARRANTIES OF MERCHANTABILITY, FITNESS FOR A PARTICULAR PURPOSE (AND THEIR EQUIVALENTS UNDER THE LAWS OF ANY JURISDICTION), OR INFRINGEMENT OF ANY PATENT, COPYRIGHT OR OTHER INTELLECTUAL PROPERTY RIGHT.

ST PRODUCTS ARE NOT DESIGNED OR AUTHORIZED FOR USE IN: (A) SAFETY CRITICAL APPLICATIONS SUCH AS LIFE SUPPORTING, ACTIVE IMPLANTED DEVICES OR SYSTEMS WITH PRODUCT FUNCTIONAL SAFETY REQUIREMENTS; (B) AERONAUTIC APPLICATIONS; (C) AUTOMOTIVE APPLICATIONS OR ENVIRONMENTS, AND/OR (D) AEROSPACE APPLICATIONS OR ENVIRONMENTS. WHERE ST PRODUCTS ARE NOT DESIGNED FOR SUCH USE, THE PURCHASER SHALL USE PRODUCTS AT PURCHASER'S SOLE RISK, EVEN IF ST HAS BEEN INFORMED IN WRITING OF SUCH USAGE, UNLESS A PRODUCT IS EXPRESSLY DESIGNATED BY ST AS BEING INTENDED FOR "AUTOMOTIVE, AUTOMOTIVE SAFETY OR MEDICAL" INDUSTRY DOMAINS ACCORDING TO ST PRODUCT DESIGN SPECIFICATIONS. PRODUCTS FORMALLY ESCC, QML OR JAN QUALIFIED ARE DEEMED SUITABLE FOR USE IN AEROSPACE BY THE CORRESPONDING GOVERNMENTAL AGENCY.

Resale of ST products with provisions different from the statements and/or technical features set forth in this document shall immediately void any warranty granted by ST for the ST product or service described herein and shall not create or extend in any manner whatsoever, any liability of ST.

ST and the ST logo are trademarks or registered trademarks of ST in various countries.

Information in this document supersedes and replaces all information previously supplied.

The ST logo is a registered trademark of STMicroelectronics. All other names are the property of their respective owners.

© 2014 STMicroelectronics - All rights reserved

STMicroelectronics group of companies

Australia - Belgium - Brazil - Canada - China - Czech Republic - Finland - France - Germany - Hong Kong - India - Israel - Italy - Japan - Malaysia - Malta - Morocco - Philippines - Singapore - Spain - Sweden - Switzerland - United Kingdom - United States of America

www.st.com

