

## MS5607-02BA03 Barometric Pressure Sensor, with stainless steel cap

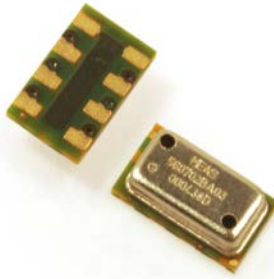

- High resolution module, 20cm
- Fast conversion down to 1 ms
- Low power, 1  $\mu$ A (standby < 0.15  $\mu$ A)
- QFN package 5.0 x 3.0 x 1.0 mm<sup>3</sup>
- Supply voltage 1.8 to 3.6 V
- Integrated digital pressure sensor (24 bit  $\Delta\Sigma$  ADC)
- Operating range: 10 to 1200 mbar, -40 to +85 °C
- I<sup>2</sup>C and SPI interface up to 20 MHz
- No external components (Internal oscillator)
- Excellent long term stability

### DESCRIPTION

The MS5607-02BA is a new generation of high resolution altimeter sensors from MEAS Switzerland with SPI and I<sup>2</sup>C bus interface. This barometric pressure sensor is optimized for altimeters and variometers with an altitude resolution of 20 cm. The sensor module includes a high linearity pressure sensor and an ultra low power 24 bit  $\Delta\Sigma$  ADC with internal factory calibrated coefficients. It provides a precise digital 24 bit pressure and temperature value and different operation modes that allow the user to optimize for conversion speed and current consumption. A high resolution temperature output allows the implementation of an altimeter/thermometer function without any additional sensor. The MS5607-02BA can be interfaced to virtually any microcontroller. The communication protocol is simple, without the need of programming internal registers in the device. Small dimensions of only 5.0 mm x 3.0 mm and a height of only 1.0 mm allow for integration in mobile devices. This new sensor module generation is based on leading MEMS technology and latest benefits from MEAS Switzerland proven experience and know-how in high volume manufacturing of altimeter modules, which have been widely used for over a decade. The sensing principle employed leads to very low hysteresis and high stability of both pressure and temperature signal.

### FEATURES

#### FIELD OF APPLICATION

Mobile altimeter / barometer systems  
Bike computers  
Variometers  
Dataloggers  
Mobile phones / GPS

#### TECHNICAL DATA

| Sensor Performances (V <sub>DD</sub> = 3 V)        |                                      |     |      |         |
|--|--------------------------------------|-----|------|---------|
| Pressure   | Min                                  | Typ | Max  | Unit    |
| Range  | 10                                   |     | 1200 | mbar    |
| ADC  | 24                                   |     |      | bit     |
| Resolution (1)                                     | 0.13 / 0.084 / 0.054 / 0.036 / 0.024 |     |      | mbar    |
| Accuracy 25°C, 750 mbar                            | -1.5                                 |     | +1.5 | mbar    |
| Error band, -20°C to +85°C<br>300 to 1100 mbar (2) | -2.5                                 |     | +2.5 | mbar    |
| Response time (1)                                  | 0.5 / 1.1 / 2.1 / 4.1 / 8.22         |     |      | ms      |
| Long term stability                                |                                      | ±1  |      | mbar/yr |
| Temperature  | Min                                  | Typ | Max  | Unit    |
| Range  | -40                                  |     | +85  | °C      |
| Resolution   | <0.01                                |     |      | °C      |
| Accuracy   | -0.8                                 |     | +0.8 | °C      |

Notes: (1) Oversampling Ratio: 256 / 512 / 1024 / 2048 / 4096  
(2) With autozero at one pressure point

#### FUNCTIONAL BLOCK DIAGRAM

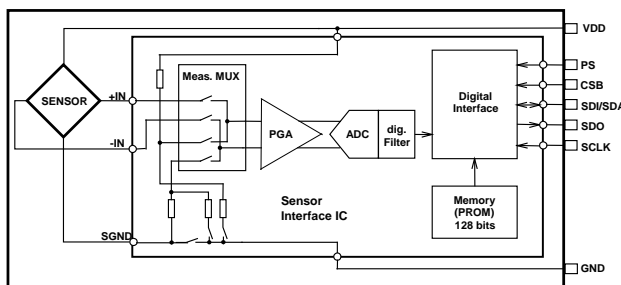

# MS5607-02BA03 Barometric Pressure Sensor, with stainless steel cap

## PERFORMANCE SPECIFICATIONS

### ABSOLUTE MAXIMUM RATINGS

| Parameter                     | Symbol           | Conditions           | Min. | Typ. | Max  | Unit |
|-------------------------------|------------------|----------------------|------|------|------|------|
| Supply voltage                | V <sub>DD</sub>  |                      | -0.3 |      | +4.0 | V    |
| Storage temperature           | T <sub>S</sub>   |                      | -40  |      | +125 | °C   |
| Overpressure                  | P <sub>max</sub> |                      |      |      | 6    | bar  |
| Maximum Soldering Temperature | T <sub>max</sub> | 40 sec max           |      |      | 250  | °C   |
| ESD rating                    |                  | Human Body Model     | -4   |      | +4   | kV   |
| Latch up                      |                  | JEDEC standard No 78 | -100 |      | +100 | mA   |

### ELECTRICAL CHARACTERISTICS

| Parameter                             | Symbol          | Conditions        | Min. | Typ. | Max  | Unit |
|---------------------------------------|-----------------|-------------------|------|------|------|------|
| Operating Supply voltage              | V <sub>DD</sub> |                   | 1.8  | 3.0  | 3.6  | V    |
| Operating Temperature                 | T               |                   | -40  | +25  | +85  | °C   |
| Supply current<br>(1 sample per sec.) | I <sub>DD</sub> | OSR 4096          |      | 12.5 |      | μA   |
|                                       |                 | 2048              |      | 6.3  |      |      |
|                                       |                 | 1024              |      | 3.2  |      |      |
|                                       |                 | 512               |      | 1.7  |      |      |
|                                       |                 | 256               |      | 0.9  |      |      |
| Peak supply current                   |                 | during conversion |      | 1.4  |      | mA   |
| Standby supply current                |                 | at 25°C           |      | 0.02 | 0.14 | μA   |
| VDD Capacitor                         |                 | From VDD to GND   | 100  |      |      | nF   |

### ANALOG DIGITAL CONVERTER (ADC)

| Parameter       | Symbol         | Conditions | Min. | Typ. | Max  | Unit |
|-----------------|----------------|------------|------|------|------|------|
| Output Word     |                |            |      | 24   |      | bit  |
| Conversion time | t <sub>c</sub> | OSR 4096   | 7.40 | 8.22 | 9.04 | ms   |
|                 |                | 2048       | 3.72 | 4.13 | 4.54 |      |
|                 |                | 1024       | 1.88 | 2.08 | 2.28 |      |
|                 |                | 512        | 0.95 | 1.06 | 1.17 |      |
|                 |                | 256        | 0.48 | 0.54 | 0.60 |      |

# MS5607-02BA03 Barometric Pressure Sensor, with stainless steel cap

## PERFORMANCE SPECIFICATIONS (CONTINUED)

### PRESSURE OUTPUT CHARACTERISTICS ( $V_{DD} = 3\text{ V}$ , $T = 25^\circ\text{C}$ UNLESS OTHERWISE NOTED)

| Parameter  | Conditions   | Min. | Typ.    | Max  | Unit    |
|--|--|------|---------|------|---------|
| Operating Pressure Range                         | $P_{\text{range}}$ Full Accuracy                     | 300  |         | 1100 | mbar    |
| Extended Pressure Range                          | $P_{\text{ext}}$ Linear Range of ADC                 | 10   |         | 1200 | mbar    |
| Total Error band, no autozero                    | at $25^\circ\text{C}$ , 700..1100 mbar               | -1.5 |         | +1.5 | mbar    |
|  | at $0..50^\circ\text{C}$ , 300..1100 mbar            | -2.0 |         | +2.0 |         |
|  | at $-20..85^\circ\text{C}$ , 300..1100 mbar          | -3.5 |         | +3.5 |         |
| Total Error band, autozero at one pressure point | at $25^\circ\text{C}$ , 700..1100 mbar               | -0.5 |         | +0.5 | mbar    |
|  | at $0..50^\circ\text{C}$ , 300..1100 mbar            | -1.0 |         | +1.0 |         |
|  | at $-20..85^\circ\text{C}$ , 300..1100 mbar          | -2.5 |         | +2.5 |         |
| Maximum error with supply voltage                | $V_{DD} = 1.8\text{ V} \dots 3.6\text{ V}$           | -2.5 |         | +2.5 | mbar    |
| Resolution RMS                                   | OSR  | 4096 | 0.024   |      | mbar    |
|  |  | 2048 | 0.036   |      |         |
|  |  | 1024 | 0.054   |      |         |
|  |  | 512  | 0.084   |      |         |
|  |  | 256  | 0.130   |      |         |
| Long-term stability                              |  |      | $\pm 1$ |      | mbar/yr |
| Reflow soldering impact                          | IPC/JEDEC J-STD-020C<br>(See application note AN808) |      | +0.4    |      | mbar    |
| Recovering time after reflow (1)                 |  |      | 7       |      | days    |

(1) Time to recovering at least 66% of the reflow impact

### TEMPERATURE OUTPUT CHARACTERISTICS ( $V_{DD} = 3\text{ V}$ , $T = 25^\circ\text{C}$ UNLESS OTHERWISE NOTED)

| Parameter                         | Conditions                                 | Min. | Typ.  | Max  | Unit             |
|-----------------------------------|--|------|-------|------|------------------|
| Absolute Accuracy                 | at $25^\circ\text{C}$                      | -0.8 |       | +0.8 | $^\circ\text{C}$ |
|                                   | $-20..85^\circ\text{C}$                    | -2.0 |       | +2.0 |                  |
|                                   | $-40..85^\circ\text{C}$                    | -4.0 |       | +4.0 |                  |
| Maximum error with supply voltage | $V_{DD} = 1.8\text{ V} \dots 3.6\text{ V}$ | -0.5 |       | +0.5 | $^\circ\text{C}$ |
| Resolution RMS                    | OSR  | 4096 | 0.002 |      | $^\circ\text{C}$ |
|                                   |  | 2048 | 0.003 |      |                  |
|                                   |  | 1024 | 0.005 |      |                  |
|                                   |  | 512  | 0.008 |      |                  |
|                                   |  | 256  | 0.012 |      |                  |

# MS5607-02BA03 Barometric Pressure Sensor, with stainless steel cap

## PERFORMANCE SPECIFICATIONS (CONTINUED)

### DIGITAL INPUTS (CSB, I<sup>2</sup>C, DIN, SCLK)

| Parameter             | Symbol   | Conditions                | Min.                | Typ. | Max                  | Unit |
|-----------------------|--|---------------------------|---------------------|------|----------------------|------|
| Serial data clock     | SCLK   | SPI protocol              |                     |      | 20                   | MHz  |
|                       |  | I <sup>2</sup> C protocol |                     |      | 400                  | KHz  |
| Input high voltage    | V <sub>IH</sub>                                | Pins CSB                  | 80% V <sub>DD</sub> |      | 100% V <sub>DD</sub> | V    |
| Input low voltage     | V <sub>IL</sub>                                |                           | 0% V <sub>DD</sub>  |      | 20% V <sub>DD</sub>  | V    |
| Input leakage current | I <sub>leak25°C</sub><br>I <sub>leak85°C</sub> | at 25°C                   |                     |      | 0.15                 | μA   |
| Input capacitance     | C <sub>IN</sub>                                |                           |                     |      | 6                    | pF   |

### PRESSURE OUTPUTS (I<sup>2</sup>C, DOUT)

| Parameter           | Symbol            | Conditions                   | Min.                | Typ. | Max                  | Unit |
|---------------------|-------------------|------------------------------|---------------------|------|----------------------|------|
| Output high voltage | V <sub>OH</sub>   | I <sub>source</sub> = 1.0 mA | 80% V <sub>DD</sub> |      | 100% V <sub>DD</sub> | V    |
| Output low voltage  | V <sub>OL</sub>   | I <sub>sink</sub> = 1.0 mA   | 0% V <sub>DD</sub>  |      | 20% V <sub>DD</sub>  | V    |
| Load capacitance    | C <sub>LOAD</sub> |                              |                     |      | 16                   | pF   |

## MS5607-02BA03 Barometric Pressure Sensor, with stainless steel cap

### FUNCTIONAL DESCRIPTION

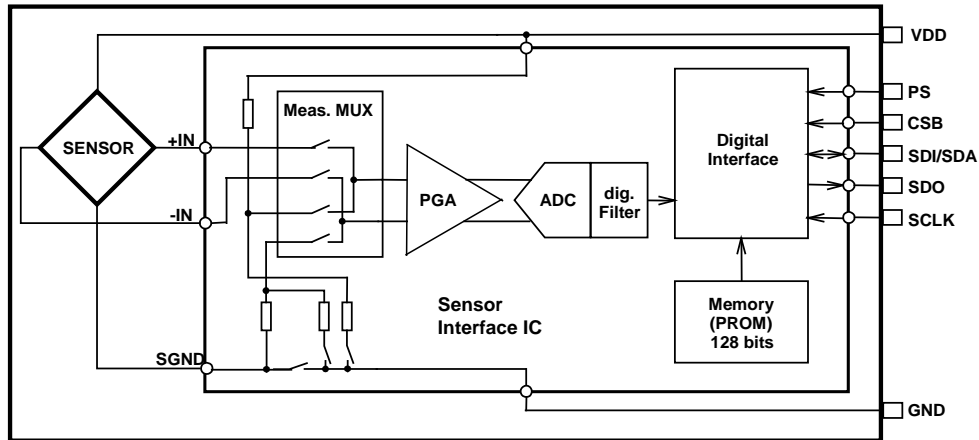

Figure 1: Block diagram of MS5607-02BA

#### GENERAL

The MS5607-02BA consists of a piezo-resistive sensor and a sensor interface IC. The main function of the MS5607-02BA is to convert the uncompensated analogue output voltage from the piezo-resistive pressure sensor to a 24-bit digital value, as well as providing a 24-bit digital value for the temperature of the sensor.

#### FACTORY CALIBRATION

Every module is individually factory calibrated at two temperatures and two pressures. As a result, 6 coefficients necessary to compensate for process variations and temperature variations are calculated and stored in the 128-bit PROM of each module. These bits (partitioned into 6 coefficients) must be read by the microcontroller software and used in the program converting D1 and D2 into compensated pressure and temperature values.

#### SERIAL INTERFACE

The MS5607-02BA has built in two types of serial interfaces: SPI and I<sup>2</sup>C. Pulling the Protocol Select pin PS to low selects the SPI protocol, pulling PS to high activates the I<sup>2</sup>C bus protocol.

| Pin PS | Mode             | Pins used     |
|--------|------------------|---------------|
| High   | I <sup>2</sup> C | SDA           |
| Low    | SPI              | SDI, SDO, CSB |

#### SPI MODE

The external microcontroller clocks in the data through the input SCLK (Serial CLock) and SDI (Serial Data In). In the SPI mode module can accept both mode 0 and mode 3 for the clock polarity and phase. The sensor responds on the output SDO (Serial Data Out). The pin CSB (Chip Select) is used to enable/disable the interface, so that other devices can talk on the same SPI bus. The CSB pin can be pulled high after the command is sent or after the end of the command execution (for example end of conversion). The best noise performance from the module is obtained when the SPI bus is idle and without communication to other devices during the ADC conversion.

## MS5607-02BA03 Barometric Pressure Sensor, with stainless steel cap

### I<sup>2</sup>C MODE

The external microcontroller clocks in the data through the input SCLK (Serial CLock) and SDA (Serial DAta). The sensor responds on the same pin SDA which is bidirectional for the I<sup>2</sup>C bus interface. So this interface type uses only 2 signal lines and does not require a chip select, which can be favourable to reduce board space. In I<sup>2</sup>C-Mode the complement of the pin CSB (Chip Select) represents the LSB of the I<sup>2</sup>C address. It is possible to use two sensors with two different addresses on the I<sup>2</sup>C bus. The pin CSB shall be connected to VDD or GND (do not leave unconnected!).

### COMMANDS

The MS5607-02BA has only five basic commands:

1. Reset
2. Read PROM (128 bit of calibration words)
3. D1 conversion
4. D2 conversion
5. Read ADC result (24 bit pressure / temperature)

# MS5607-02BA03 Barometric Pressure Sensor, with stainless steel cap

## PRESSURE AND TEMPERATURE CALCULATION

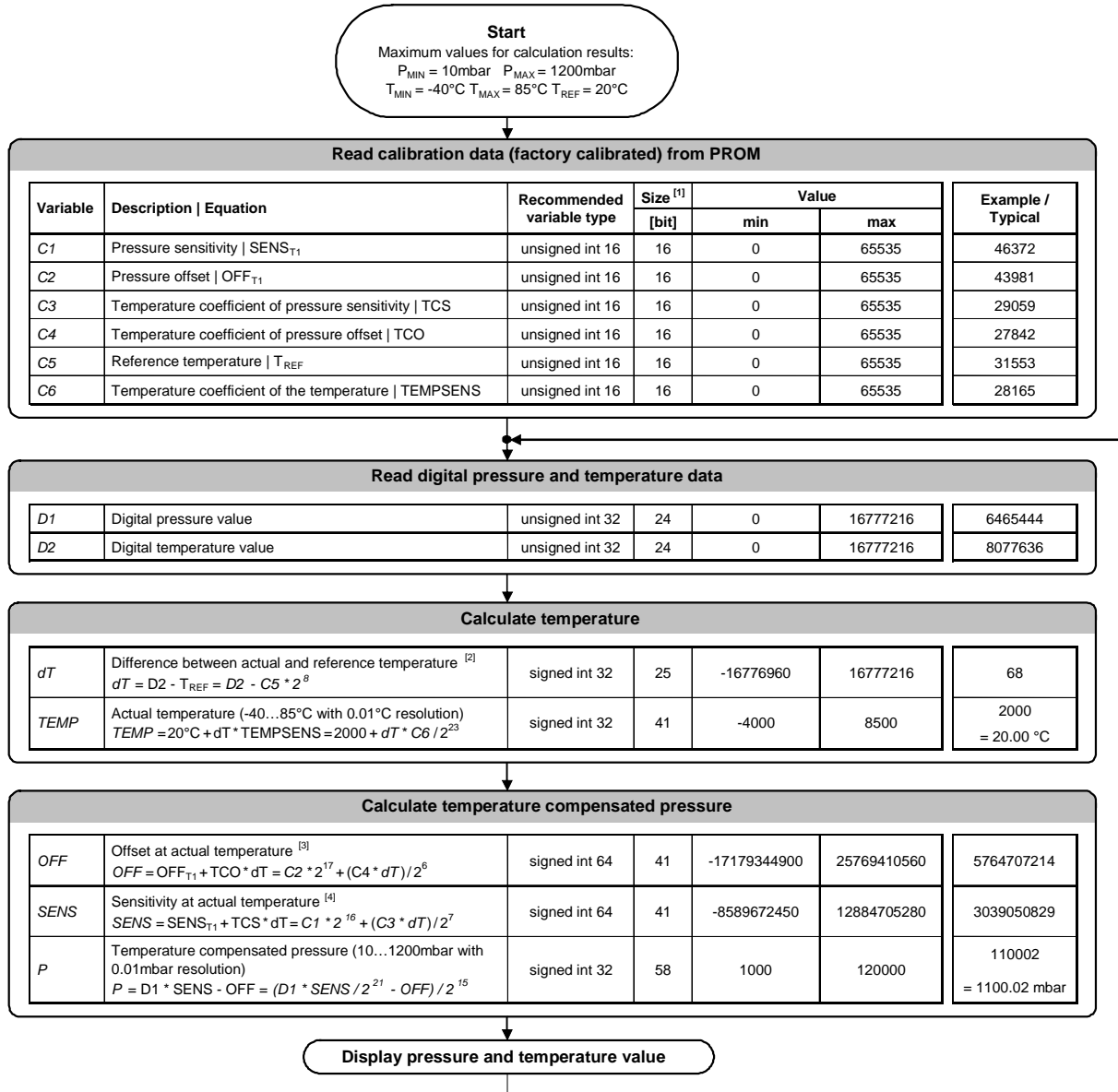

Notes

- [1] Maximal size of intermediate result during evaluation of variable
- [2] min and max have to be defined
- [3] min and max have to be defined
- [4] min and max have to be defined

Figure 2: Flow chart for pressure and temperature reading and software compensation.

## MS5607-02BA03 Barometric Pressure Sensor, with stainless steel cap

### SECOND ORDER TEMPERATURE COMPENSATION

In order to obtain best accuracy over temperature range, particularly in low temperature, it is recommended to compensate the non-linearity over the temperature. This can be achieved by correcting the calculated temperature, offset and sensitivity by a second order correction factor and will be recalculated with the standard calculation. The second-order factors are calculated as follows:

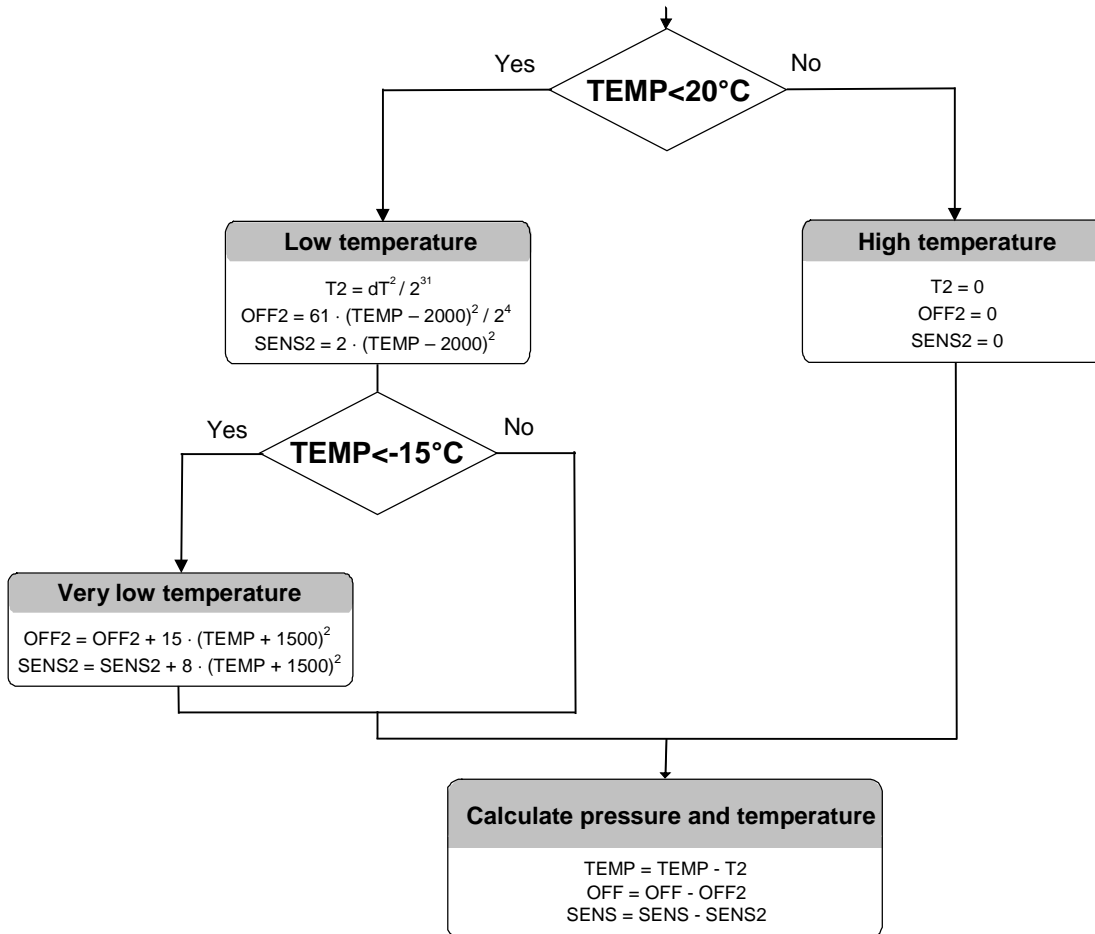

Figure 3: Flow chart for pressure and temperature to the optimum accuracy.



# MS5607-02BA03 Barometric Pressure Sensor, with stainless steel cap

## SPI INTERFACE

### COMMANDS

Size of each command is 1 byte (8 bits) as described in the table below. After ADC read commands the device will return 24 bit result and after the PROM read 16bit result. The address of the PROM is embedded inside of the PROM read command using the a2, a1 and a0 bits.

| Bit number            | Command byte |     |   |     |             |             |             |      | hex value       |
|-----------------------|--------------|-----|---|-----|-------------|-------------|-------------|------|-----------------|
|                       | 0            | 1   | 2 | 3   | 4           | 5           | 6           | 7    |                 |
| Bit name              | PR<br>M      | COV | - | Typ | Ad2/<br>Os2 | Ad1/<br>Os1 | Ad0/<br>Os0 | Stop |                 |
| Command               |              |     |   |     |             |             |             |      |                 |
| Reset                 | 0            | 0   | 0 | 1   | 1           | 1           | 1           | 0    | 0x1E            |
| Convert D1 (OSR=256)  | 0            | 1   | 0 | 0   | 0           | 0           | 0           | 0    | 0x40            |
| Convert D1 (OSR=512)  | 0            | 1   | 0 | 0   | 0           | 0           | 1           | 0    | 0x42            |
| Convert D1 (OSR=1024) | 0            | 1   | 0 | 0   | 0           | 1           | 0           | 0    | 0x44            |
| Convert D1 (OSR=2048) | 0            | 1   | 0 | 0   | 0           | 1           | 1           | 0    | 0x46            |
| Convert D1 (OSR=4096) | 0            | 1   | 0 | 0   | 1           | 0           | 0           | 0    | 0x48            |
| Convert D2 (OSR=256)  | 0            | 1   | 0 | 1   | 0           | 0           | 0           | 0    | 0x50            |
| Convert D2 (OSR=512)  | 0            | 1   | 0 | 1   | 0           | 0           | 1           | 0    | 0x52            |
| Convert D2 (OSR=1024) | 0            | 1   | 0 | 1   | 0           | 1           | 0           | 0    | 0x54            |
| Convert D2 (OSR=2048) | 0            | 1   | 0 | 1   | 0           | 1           | 1           | 0    | 0x56            |
| Convert D2 (OSR=4096) | 0            | 1   | 0 | 1   | 1           | 0           | 0           | 0    | 0x58            |
| ADC Read              | 0            | 0   | 0 | 0   | 0           | 0           | 0           | 0    | 0x00            |
| PROM Read             | 1            | 0   | 1 | 0   | Ad2         | Ad1         | Ad0         | 0    | 0xA0 to<br>0xAE |

Figure 4: Command structure

### RESET SEQUENCE

The Reset sequence shall be sent once after power-on to make sure that the calibration PROM gets loaded into the internal register. It can be also used to reset the device ROM from an unknown condition

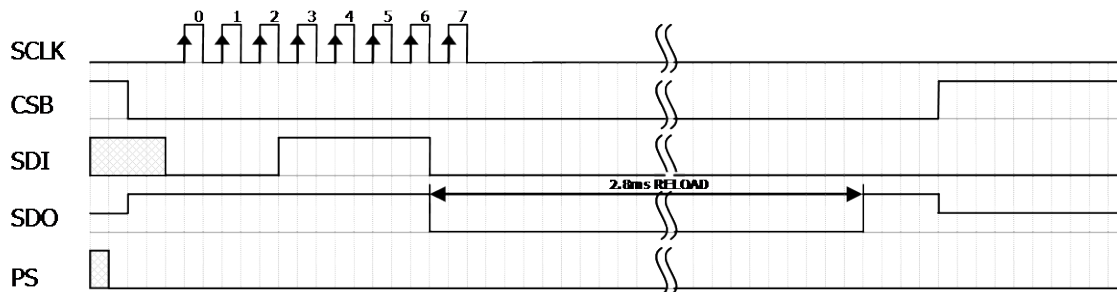

Figure 5: Reset command sequence SPI mode 0

## MS5607-02BA03 Barometric Pressure Sensor, with stainless steel cap

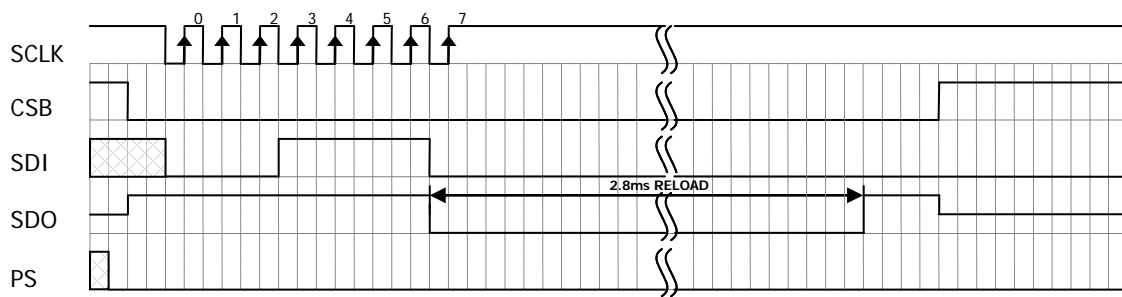

Figure 6: Reset command sequence SPI mode 3

### CONVERSION SEQUENCE

The conversion command is used to initiate uncompensated pressure (D1) or uncompensated temperature (D2) conversion. The chip select can be disabled during this time to communicate with other devices. After the conversion, using ADC read command the result is clocked out with the MSB first. If the conversion is not executed before the ADC read command, or the ADC read command is repeated, it will give 0 as the output result. If the ADC read command is sent during conversion the result will be 0, the conversion will not stop and the final result will be wrong. Conversion sequence sent during the already started conversion process will yield incorrect result as well.

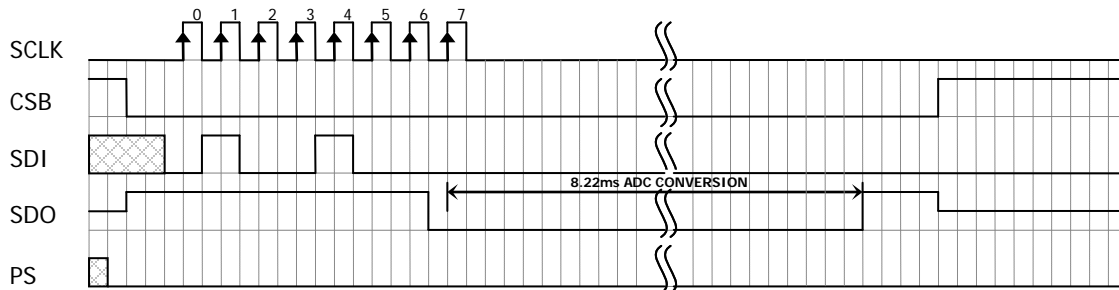

Figure 7: Conversion out sequence, Typ=d1, OSR = 4096

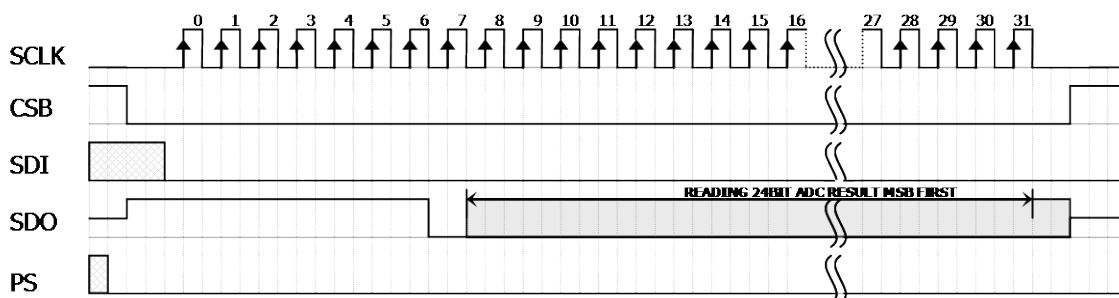

Figure 8: ADC Read sequence

### PROM READ SEQUENCE

The read command for PROM shall be executed once after reset by the user to read the content of the calibration PROM and to calculate the calibration coefficients. There are in total 8 addresses resulting in a total memory of 128 bit. Address 0 contains factory data and the setup, addresses 1-6 calibration coefficients and address 7 contains the serial code and CRC. The command sequence is 8 bits long with a 16 bit result which is clocked with the MSB first.

# MS5607-02BA03 Barometric Pressure Sensor, with stainless steel cap

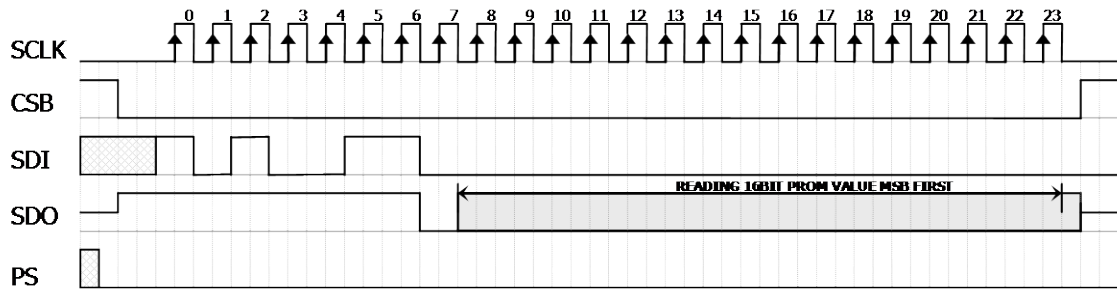

Figure 9: PROM Read sequence, address = 011 (Coefficient 3).

## I<sup>2</sup>C INTERFACE

### COMMANDS

Each I<sup>2</sup>C communication message starts with the start condition and it is ended with the stop condition. The MS5607-02BA address is 111011Cx, where C is the complementary value of the pin CSB. Since the IC does not have a microcontroller inside, the commands for I<sup>2</sup>C and SPI are quite similar.

### RESET SEQUENCE

The reset can be sent at any time. In the event that there is not a successful power on reset this may be caused by the SDA being blocked by the module in the acknowledge state. The only way to get the MS5607-02BA to function is to send several SCLKs followed by a reset sequence or to repeat power on reset.

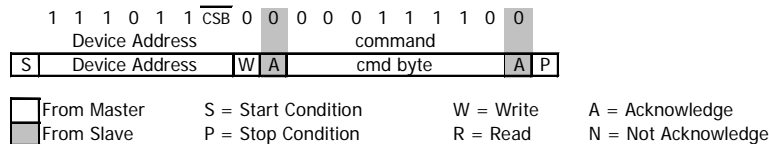

Figure 10: I<sup>2</sup>C Reset Command

### PROM READ SEQUENCE

The PROM Read command consists of two parts. First command sets up the system into PROM read mode. The second part gets the data from the system.

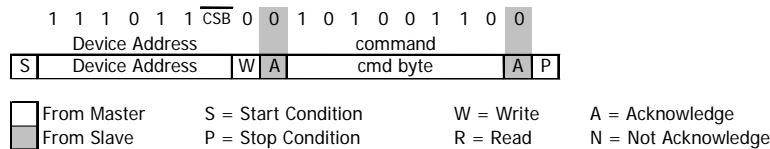

Figure 11: I<sup>2</sup>C Command to read memory address= 011 (Coefficient 3)

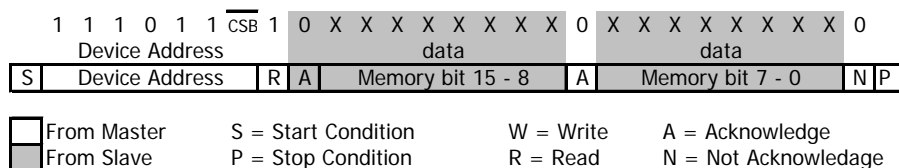

Figure 12: I<sup>2</sup>C answer from MS5607-02BA

# MS5607-02BA03 Barometric Pressure Sensor, with stainless steel cap

## CONVERSION SEQUENCE

A conversion can be started by sending the command to MS5607-02BA. When command is sent to the system it stays busy until conversion is done. When conversion is finished the data can be accessed by sending a Read command, when an acknowledge appears from the MS5607-02BA, 24 SCLK cycles may be sent to receive all result bits. Every 8 bit the system waits for an acknowledge signal.

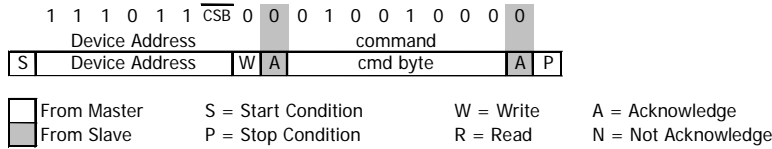

Figure 13: I<sup>2</sup>C Command to initiate a pressure conversion (OSR=4096, typ=D1)

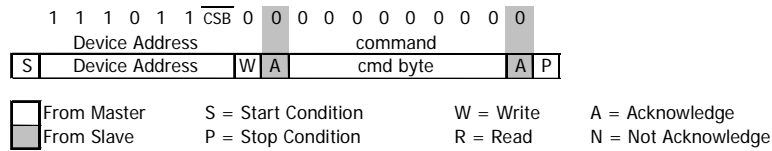

Figure 14: I<sup>2</sup>C ADC read sequence

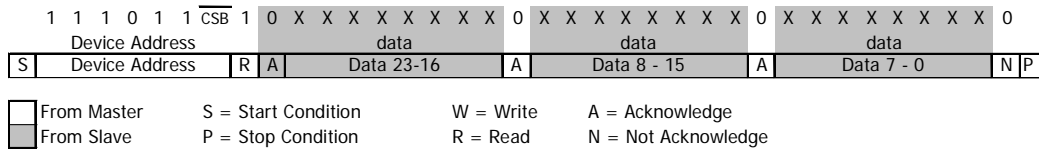

Figure 15: I<sup>2</sup>C answer from MS5607-02BA

## CYCLIC REDUNDANCY CHECK (CRC)

MS5607-02BA contains a PROM memory with 128-Bit. A 4-bit CRC has been implemented to check the data validity in memory. The application note AN520 describes in detail CRC-4 code used.

|   |                                  |   |   |   |   |   |   |   |   |   |   |   |   |   |   |   |     |
|---|----------------------------------|---|---|---|---|---|---|---|---|---|---|---|---|---|---|---|-----|
| A | D                                | D | D | D | D | D | D | D | D | D | D | D | D | D | D | D | D   |
| d | B                                | B | B | B | B | B | B | B | B | B | B | B | B | B | B | B | B   |
| d | 1                                | 1 | 1 | 1 | 1 | 1 | 9 | 8 | 7 | 6 | 5 | 4 | 3 | 2 | 1 | 0 |     |
| 0 | 16 bit reserved for manufacturer |   |   |   |   |   |   |   |   |   |   |   |   |   |   |   |     |
| 1 | Coefficient 1 (16 bit unsigned)  |   |   |   |   |   |   |   |   |   |   |   |   |   |   |   |     |
| 2 | Coefficient 2 (16 bit unsigned)  |   |   |   |   |   |   |   |   |   |   |   |   |   |   |   |     |
| 3 | Coefficient 3 (16 bit unsigned)  |   |   |   |   |   |   |   |   |   |   |   |   |   |   |   |     |
| 4 | Coefficient 4 (16 bit unsigned)  |   |   |   |   |   |   |   |   |   |   |   |   |   |   |   |     |
| 5 | Coefficient 5 (16 bit unsigned)  |   |   |   |   |   |   |   |   |   |   |   |   |   |   |   |     |
| 6 | Coefficient 6 (16 bit unsigned)  |   |   |   |   |   |   |   |   |   |   |   |   |   |   |   |     |
| 7 |                                  |   |   |   |   |   |   |   |   |   |   |   |   |   |   |   | CRC |

Figure 16: Memory PROM mapping

# MS5607-02BA03 Barometric Pressure Sensor, with stainless steel cap

## APPLICATION CIRCUIT

The MS5607-02BA is a circuit that can be used in conjunction with a microcontroller in mobile altimeter applications. It is designed for low-voltage systems with a supply voltage of 3 V.

### SPI protocol communication

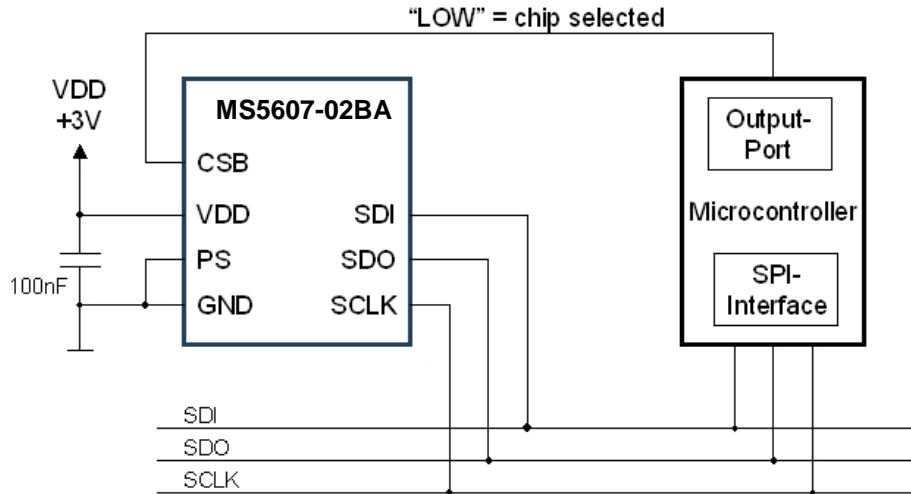

### I<sup>2</sup>C protocol communication

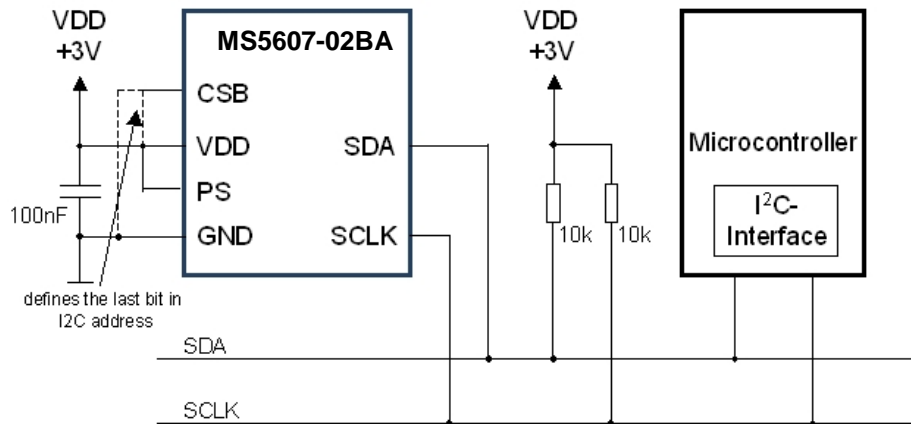
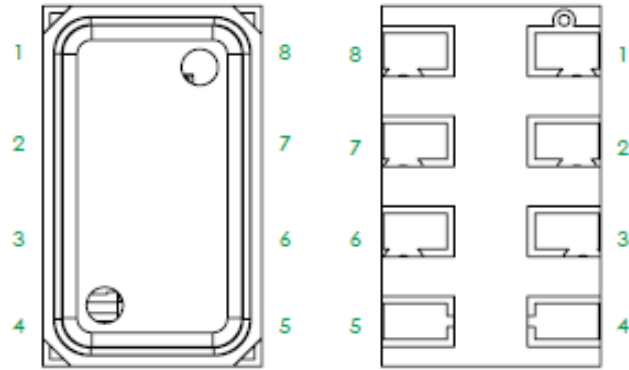

Figure 17: Typical application circuit with SPI / I<sup>2</sup>C protocol communication

# MS5607-02BA03 Barometric Pressure Sensor, with stainless steel cap

## PIN CONFIGURATION

| Pin | Name         | Type   | Function  |
|-----|--------------|--------|---|
| 1   | VDD          | P      | Positive supply voltage   |
| 2   | PS           | I      | Protocol select<br>PS high (VDD) → I <sup>2</sup> C<br>PS low (GND) → SPI |
| 3   | GND          | G      | Ground  |
| 4   | CSB          | I      | Chip select (active low),<br>internal connection                          |
| 5   |              |        |   |
| 6   | SDO          | O      | Serial data output  |
| 7   | SDI /<br>SDA | I / IO | Serial data input /<br>I <sup>2</sup> C data IO                           |
| 8   | SCLK         | I      | Serial data clock   |



## DEVICE PACKAGE OUTLINE

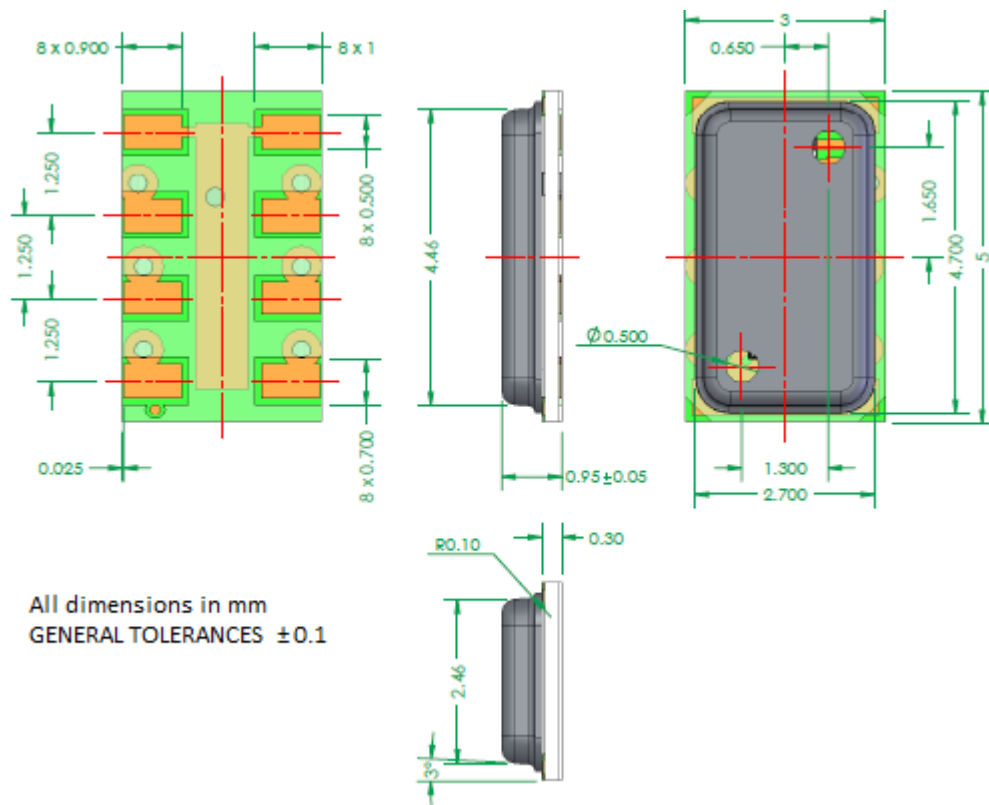
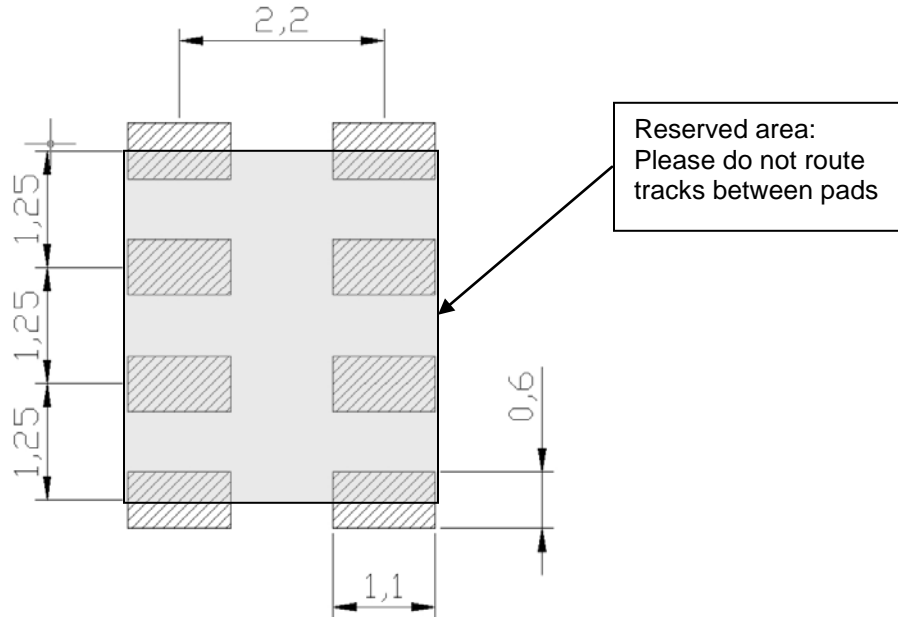

Figure 18: MS5607-02BA03 package outline

# MS5607-02BA03 Barometric Pressure Sensor, with stainless steel cap

## RECOMMENDED PAD LAYOUT

Pad layout for bottom side of the MS5607-02BA soldered onto printed circuit board.



## SHIPPING PACKAGE

Tape and Tape and reel

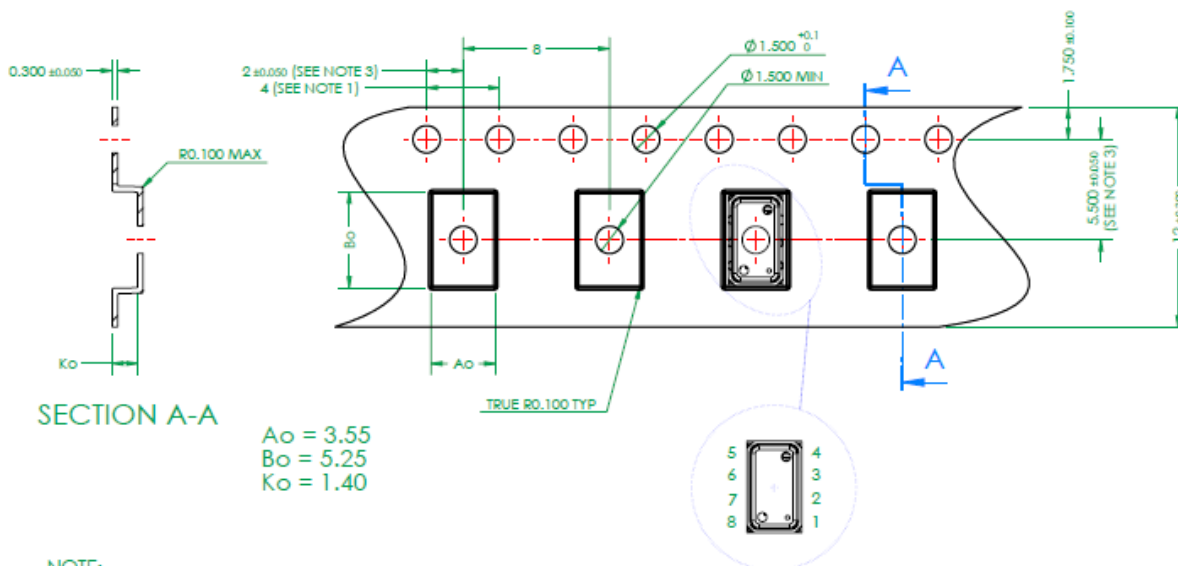

NOTE:

- 1: 10 SPROCKET HOLE PITCH CUMULATIVE TOLERANCE  $\pm 0.2$
- 2: CAMBER IN COMPLIANCE WITH EIA 481
- 3: POCKET POSITION RELATIVE TO SPROCKET HOLE  
MEASURED AS TRUE POSITION OF POCKET, NOT POCKET HOLE

## MS5607-02BA03 Barometric Pressure Sensor, with stainless steel cap

---

### MOUNTING AND ASSEMBLY CONSIDERATIONS

---

#### SOLDERING

Please refer to the application note AN808 available on our website for all soldering issues.

#### MOUNTING

The MS5607-02BA can be placed with automatic Pick & Place equipment using vacuum nozzles. It will not be damaged by the vacuum. Due to the low stress assembly the sensor does not show pressure hysteresis effects. It is important to solder all contact pads.

#### CONNECTION TO PCB

The package outline of the module allows the use of a flexible PCB for interconnection. This can be important for applications in watches and other special devices.

#### CLEANING

The MS5607-02BA has been manufactured under cleanroom conditions. It is therefore recommended to assemble the sensor under class 10'000 or better conditions. Should this not be possible, it is recommended to protect the sensor opening during assembly from entering particles and dust. To avoid cleaning of the PCB, solder paste of type "no-clean" shall be used. Cleaning might damage the sensor!

#### ESD PRECAUTIONS

The electrical contact pads are protected against ESD up to 4 kV HBM (human body model). It is therefore essential to ground machines and personnel properly during assembly and handling of the device. The MS5607-02BA is shipped in antistatic transport boxes. Any test adapters or production transport boxes used during the assembly of the sensor shall be of an equivalent antistatic material.

#### DECOUPLING CAPACITOR

Particular care must be taken when connecting the device to the power supply. A 100 nF ceramic capacitor must be placed as close as possible to the MS5607-02BA VDD pin. This capacitor will stabilize the power supply during data conversion and thus, provide the highest possible accuracy.



# MS5607-02BA03 Barometric Pressure Sensor, with stainless steel cap

## TYPICAL PERFORMANCE CHARACTERISTICS

Absolute Pressure Accuracy, 2nd order compensation

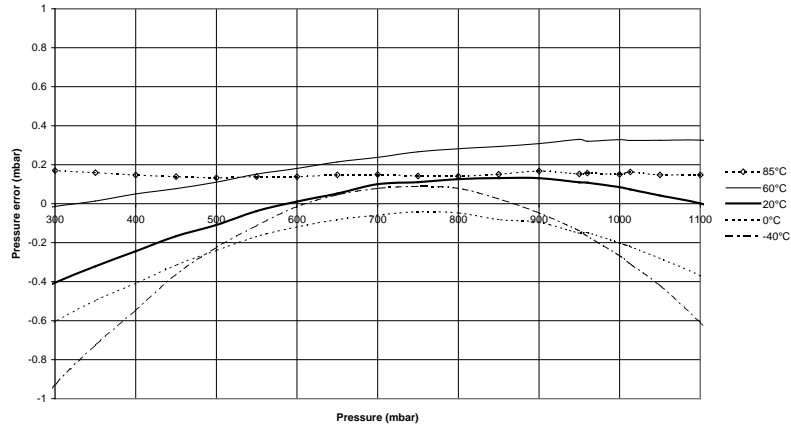

Pressure Error Accuracy vs temperature

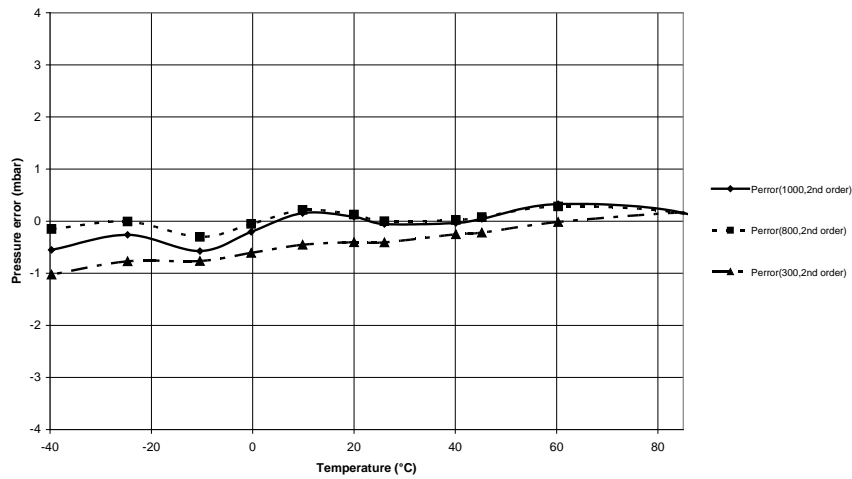

Temperature Error Accuracy vs temperature

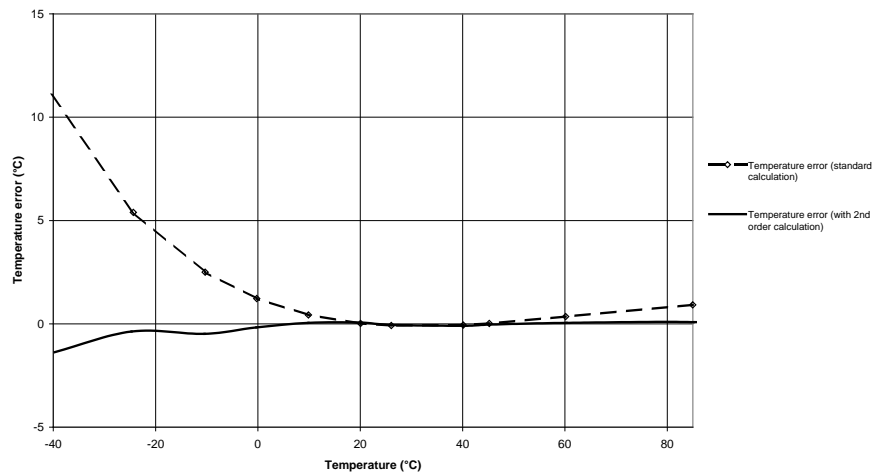

# MS5607-02BA03 Barometric Pressure Sensor, with stainless steel cap

## TYPICAL PERFORMANCE CHARACTERISTICS (CONTINUED)

Pressure error vs supply voltage (typical)

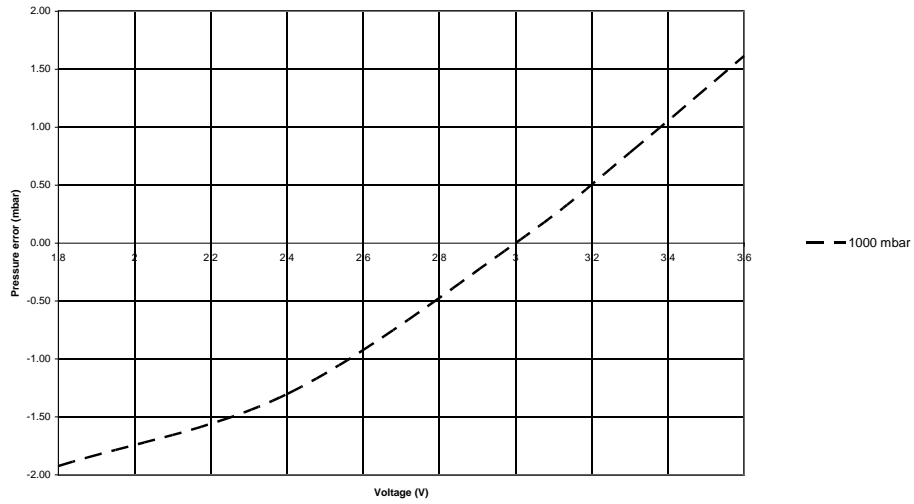

Temperature error vs supply voltage (typical)

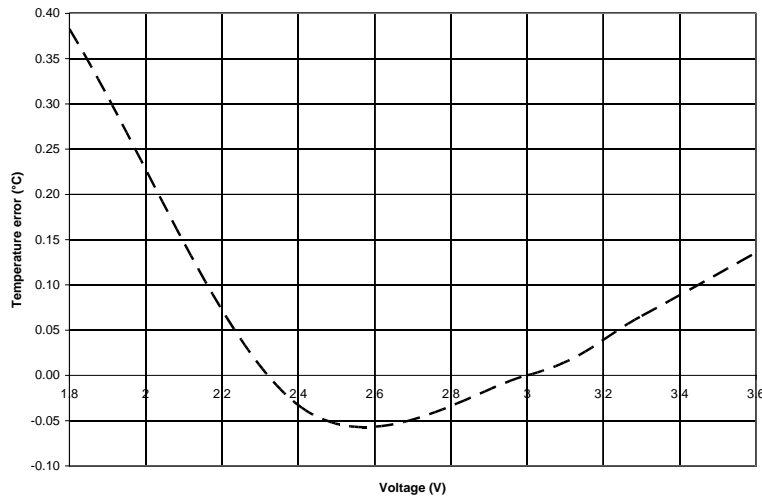

## MS5607-02BA03 Barometric Pressure Sensor, with stainless steel cap

### ORDERING INFORMATION

| Product Code  | Product                                      | Art. No         | Delivery Form |
|---------------|--|-----------------|---------------|
| MS5607-02BA03 | Barometric Pressure Sensor<br>Thin Metal Cap | MS560702BA03-00 | Waffle pack   |
| MS5607-02BA03 | Barometric Pressure Sensor<br>Thin Metal Cap | MS560702BA03-50 | Tape and reel |

### FACTORY CONTACTS

#### NORTH AMERICA

Measurement Specialties  
45738 Northport Loop West  
Fremont, CA 94538

Tel: +1 800 767 1888  
Fax: +1 510 498 1578  
e-mail: [pfg.cs.amer@meas-spec.com](mailto:pfg.cs.amer@meas-spec.com)  
Website: [www.meas-spec.com](http://www.meas-spec.com)

#### EUROPE

MEAS Switzerland Sàrl  
Ch. Chapons-des-Prés 11  
CH-2022 Bevaix

Tel: +41 32 847 9550  
Fax: + 41 32 847 9569  
e-mail: [sales.ch@meas-spec.com](mailto:sales.ch@meas-spec.com)  
Website: [www.meas-spec.com](http://www.meas-spec.com)

#### ASIA

Measurement Specialties (China), Ltd.  
No. 26 Langshan Road  
Shenzhen High-Tech Park (North)  
Nanshan District, Shenzhen, 518057  
China

Tel: +86 755 3330 5088  
Fax: +86 755 3330 5099  
e-mail: [pfg.cs.asia@meas-spec.com](mailto:pfg.cs.asia@meas-spec.com)  
Website: [www.meas-spec.com](http://www.meas-spec.com)

The information in this sheet has been carefully reviewed and is believed to be accurate; however, no responsibility is assumed for inaccuracies. Furthermore, this information does not convey to the purchaser of such devices any license under the patent rights to the manufacturer. Measurement Specialties, Inc. reserves the right to make changes without further notice to any product herein. Measurement Specialties, Inc. makes no warranty, representation or guarantee regarding the suitability of its product for any particular purpose, nor does Measurement Specialties, Inc. assume any liability arising out of the application or use of any product or circuit and specifically disclaims any and all liability, including without limitation consequential or incidental damages. Typical parameters can and do vary in different applications. All operating parameters must be validated for each customer application by customer's technical experts. Measurement Specialties, Inc. does not convey any license under its patent rights nor the rights of others.