

WiFi 7 click schematic v100

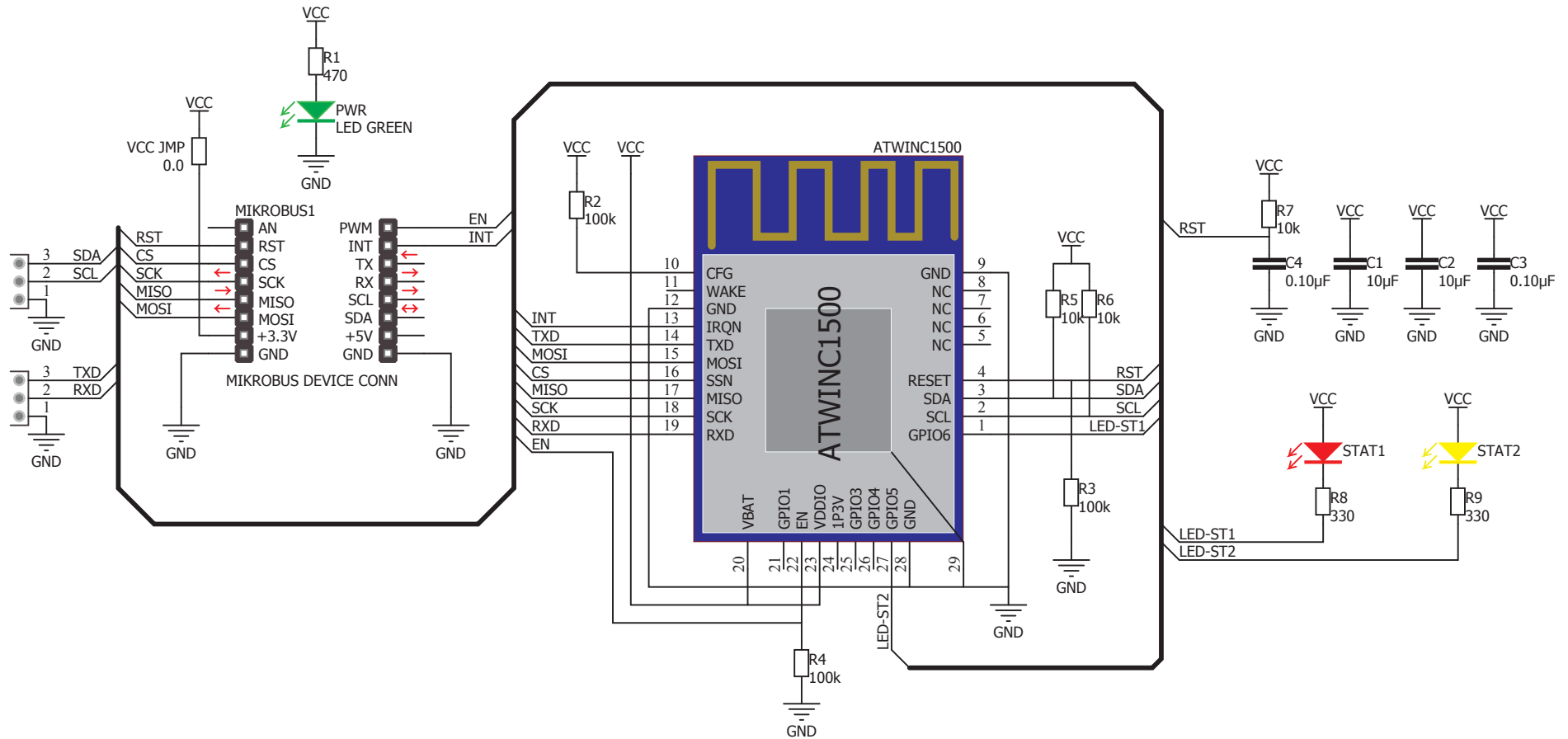

www.mikroe.com