

WiFi 6 click board™ Schematic v101

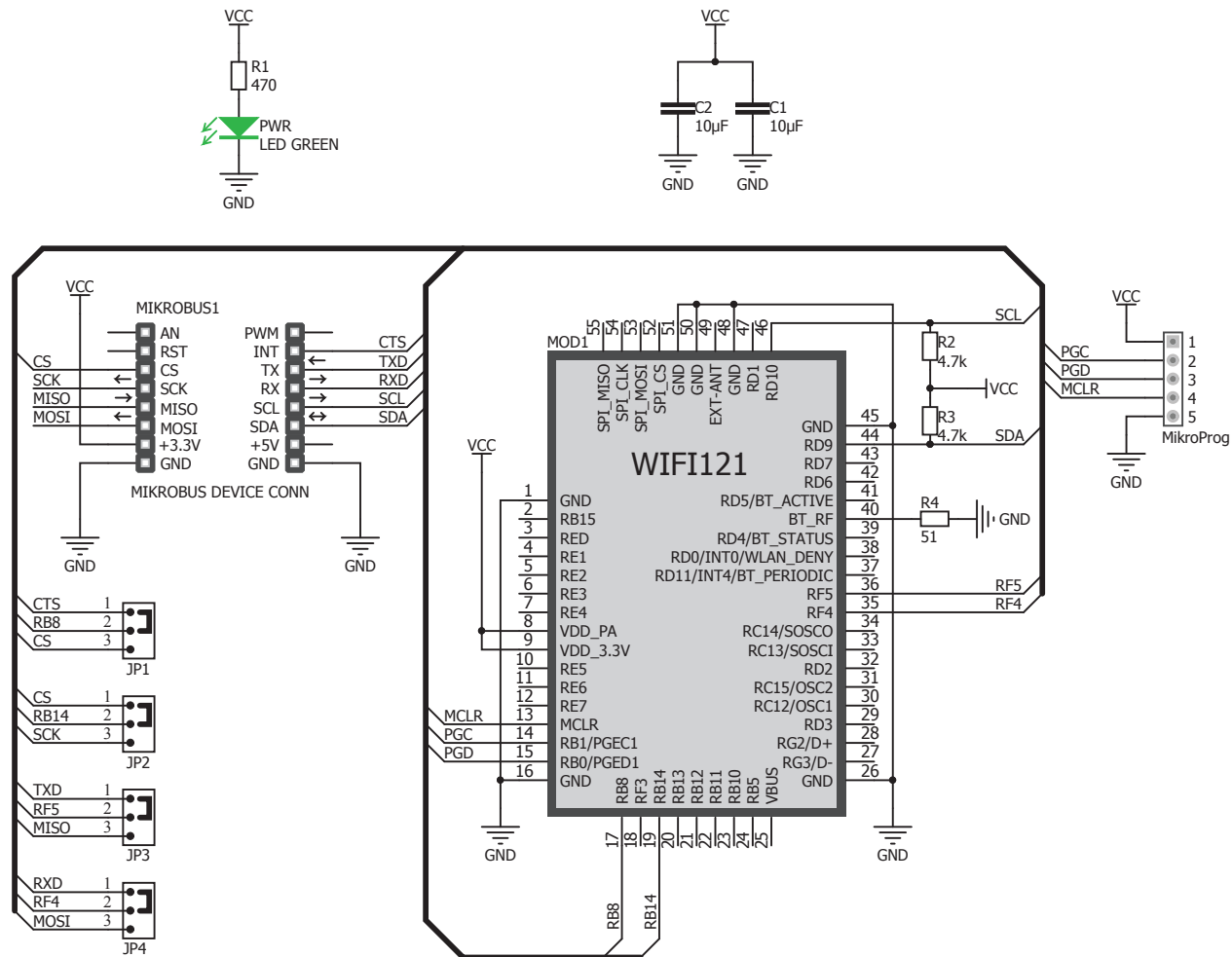

www.mikroe.com