

Thermo 32 Click schematic v100

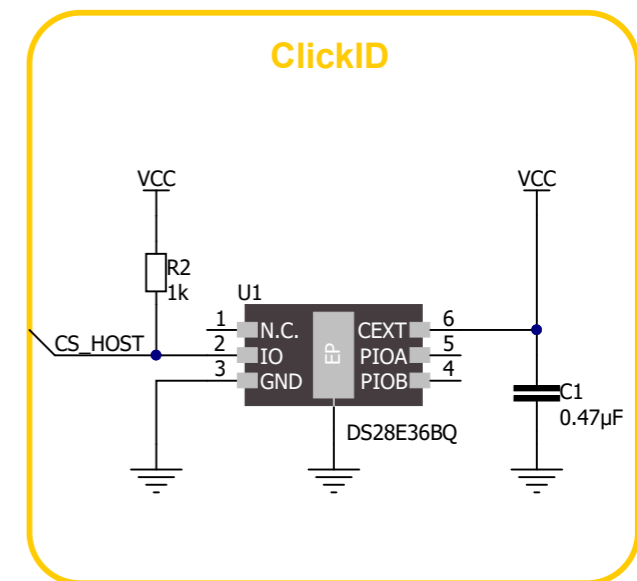
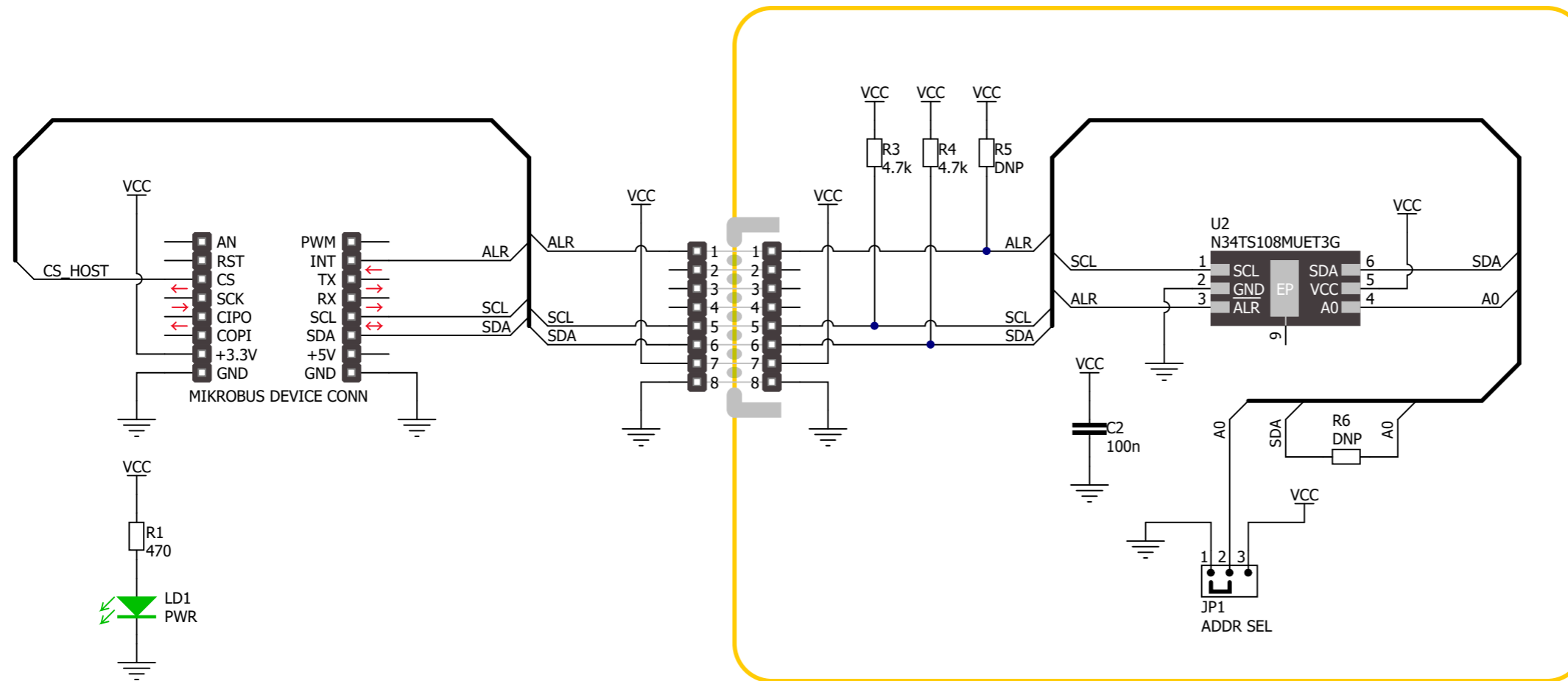

www.mikroe.com