

RTC 26 Click schematic v101

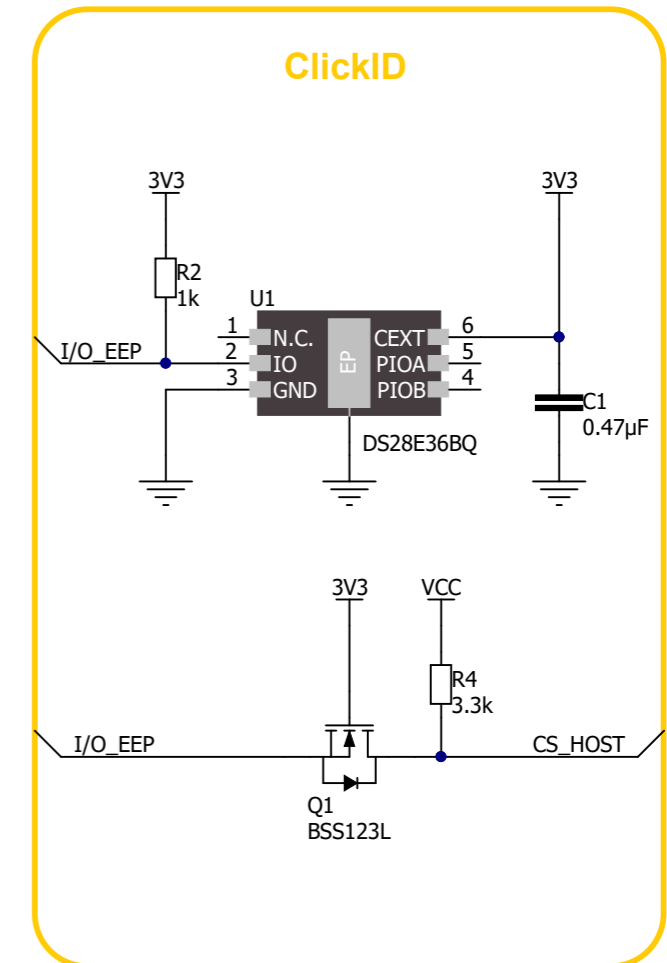
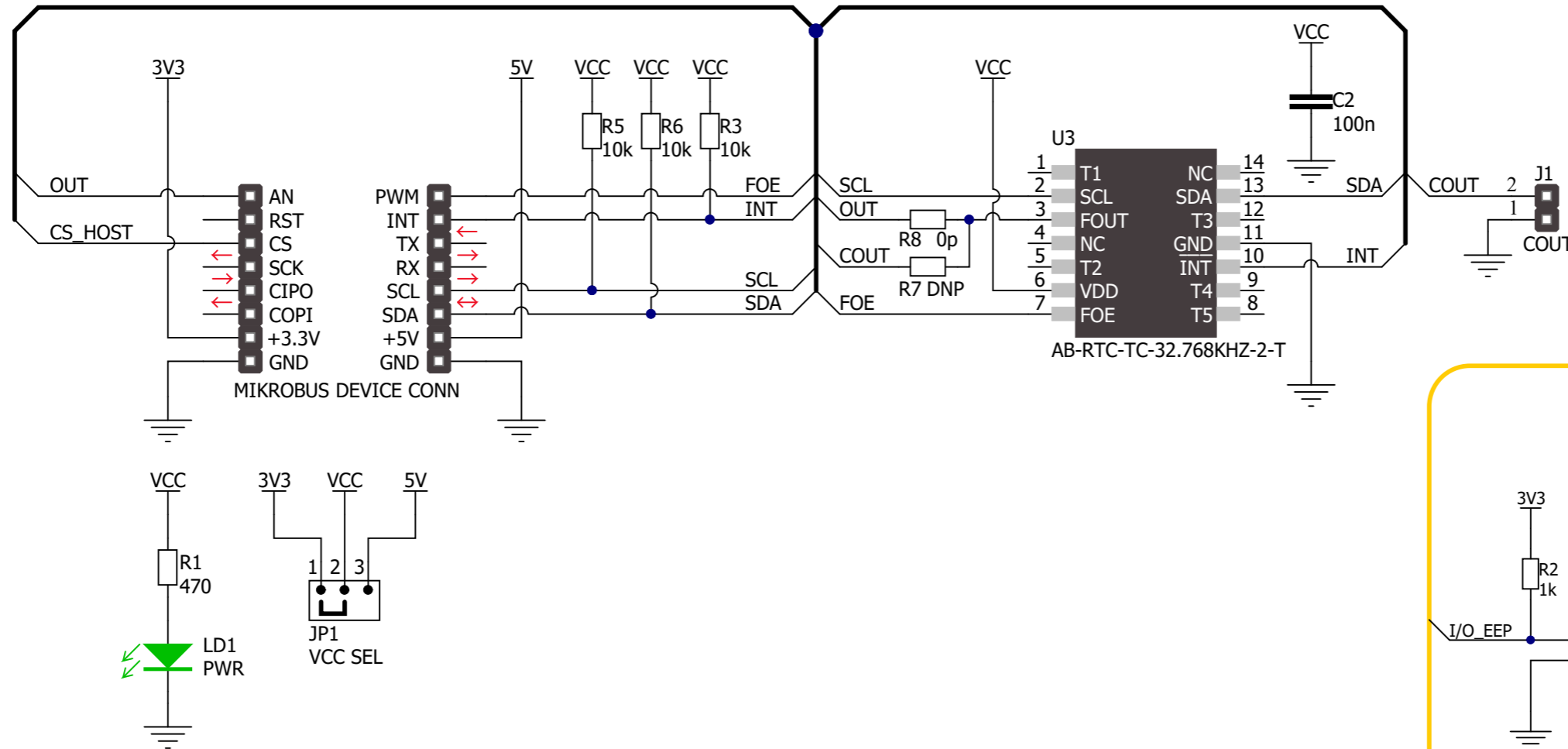

www.mikroe.com