

RTC 25 Click schematic v101

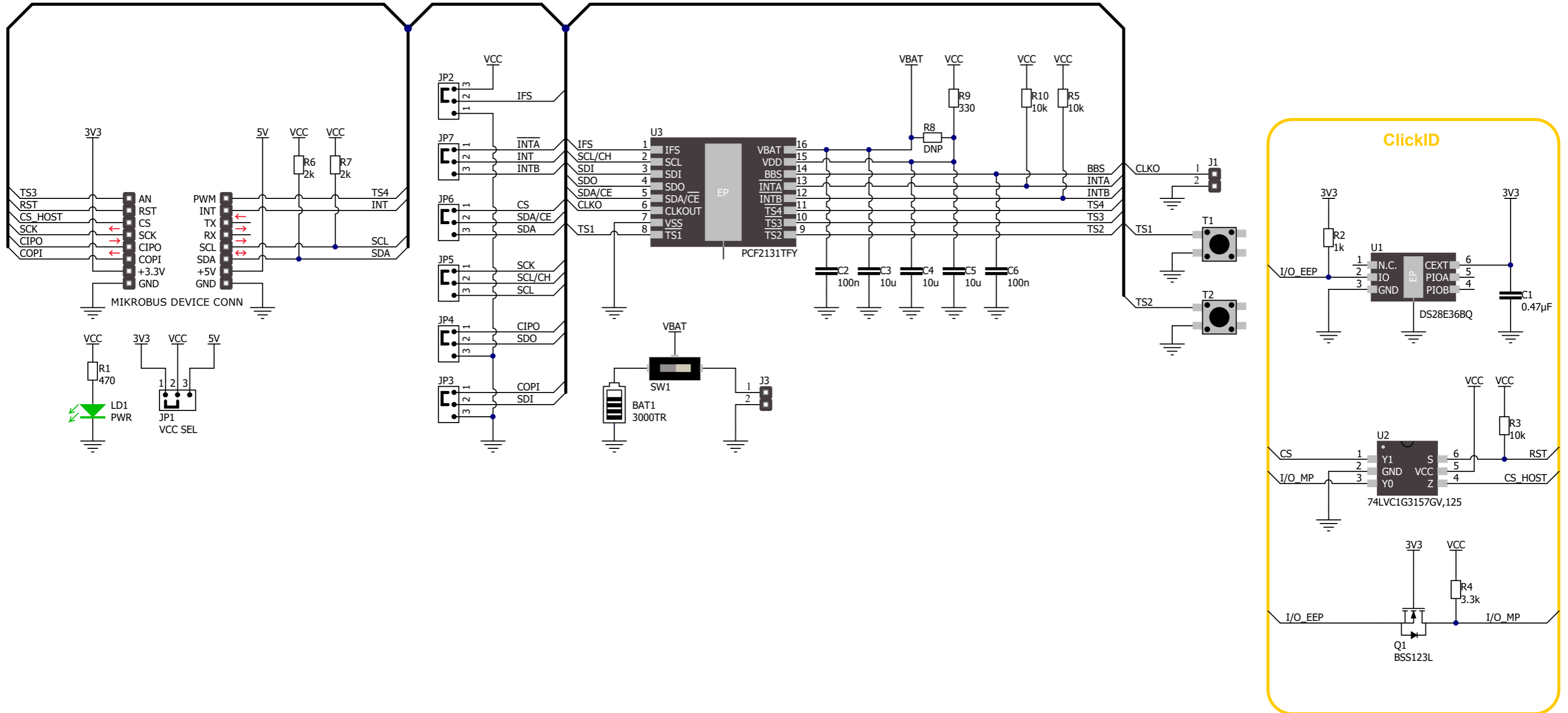

www.mikroe.com