

MCP73213 click schematic v100

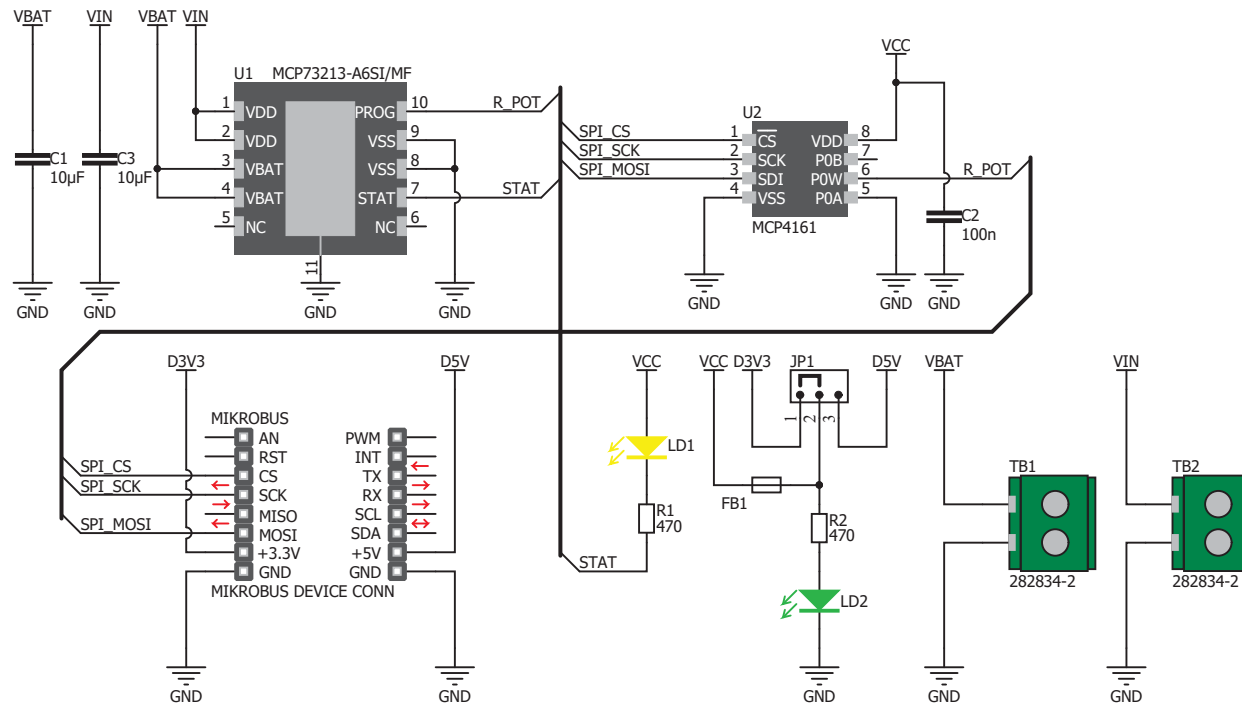

www.mikroe.com