

DAC 22 Click schematic v100

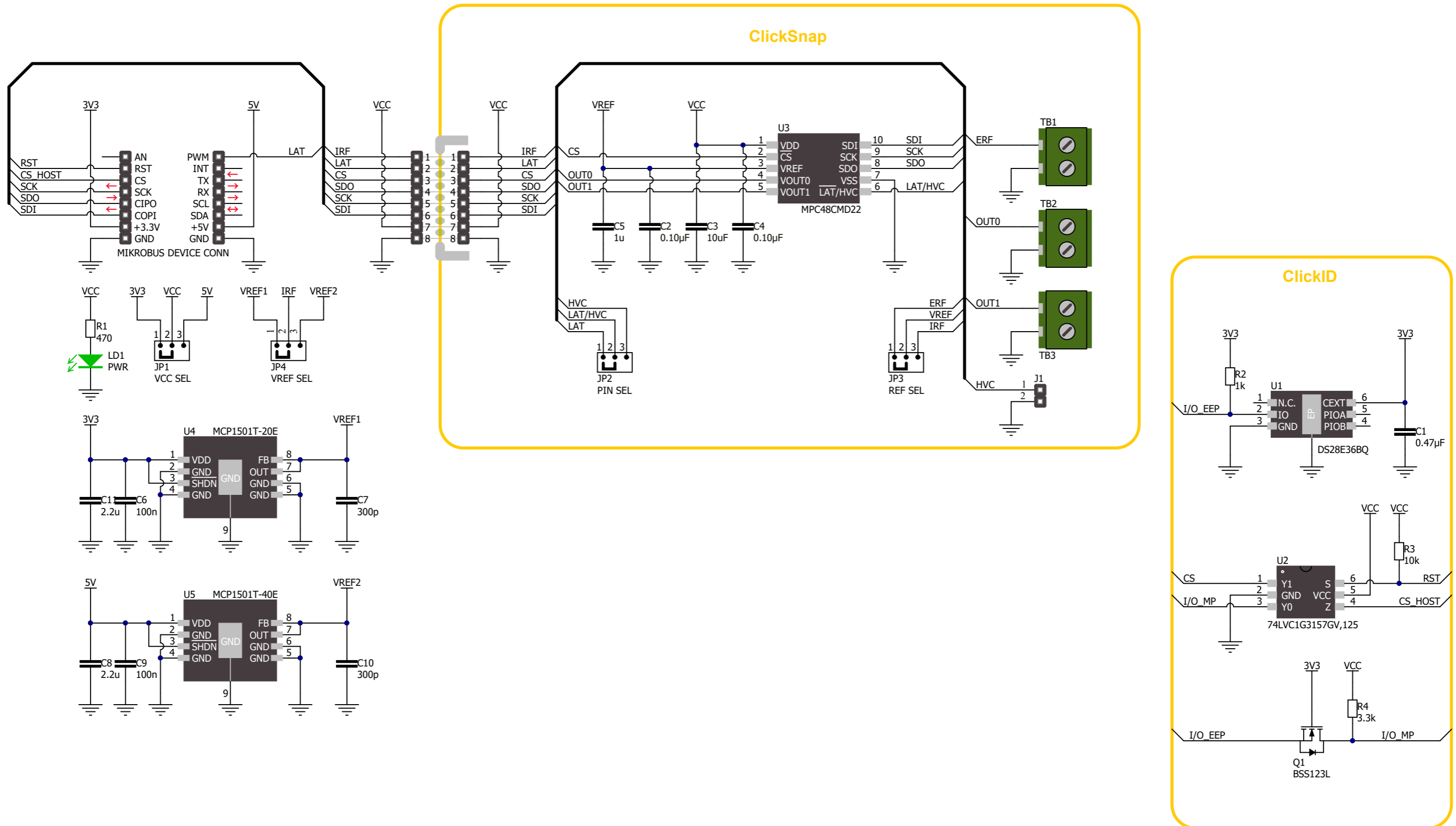

www.mikroe.com