

Accel 37 Click schematic v100

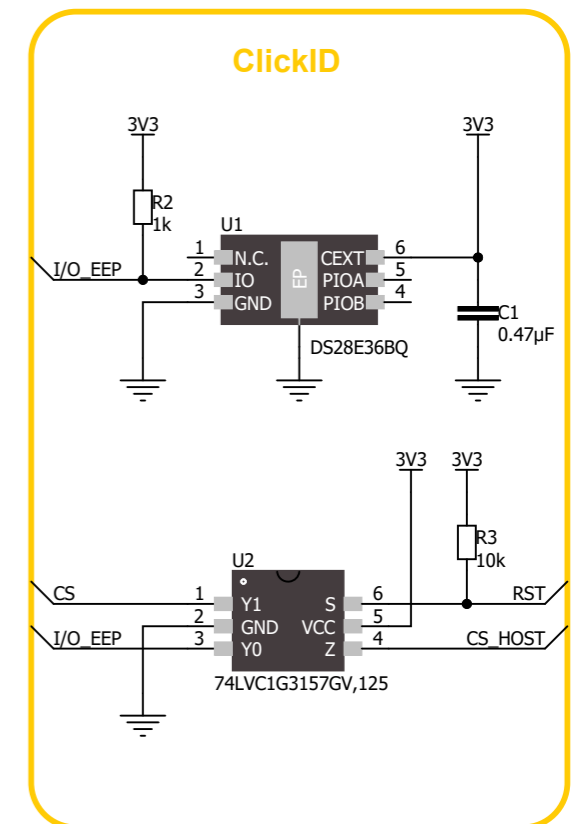
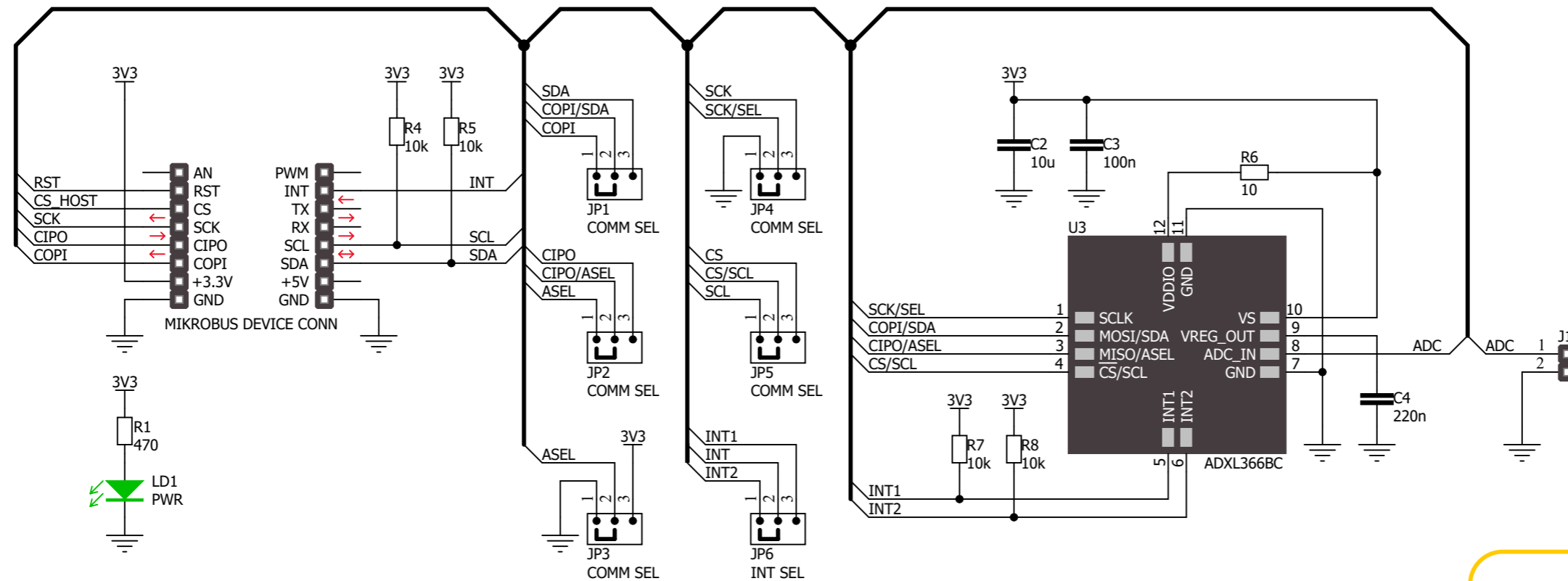

www.mikroe.com